



USER MANUAL FOR SPA

CITYLIFE

/ CONTROL SYSTEMS / KEYPADS / ACCESSORIES /



WARNING

REDUCE THE RISK OF ELECTROCUTION

- Never place an electric appliance within 5 feet of hot tub.

REDUCE THE RISK OF CHILD DROWNING

- Always supervise children.
- Attach hot tub cover after each use.

REDUCE THE RISK OF OVERHEATING

- Check with a doctor before use if pregnant, diabetic, in poor health, or under medical care.
- Exit immediately if uncomfortable, dizzy, or sleepy. Hot tub heat can cause hyperthermia and unconsciousness.
- Hot tub heat in conjunction with alcohol, drugs, or medication can cause unconsciousness.

WHEN PREGNANT, measure water temperature before entering.

- Soaking in hot water for long periods can harm your fetus.
- Exit immediately if uncomfortable, dizzy, or sleepy. Hot tub heat can cause hyperthermia and unconsciousness.
- Hot tub heat in conjunction with alcohol, drugs, or medication can cause unconsciousness.

TABLE OF CONTENTS

Introduction	2
Safety instructions	3
Safety instructions - Canada	10
Important safety instructions	13
Basic Functions	14
Connection diagram	
Lugano Life	18
Vienna Life	19
Malaga Life	20
Lima Life	21
Prague Life	22
Manhattan Life	23
Milano P&P	24
Oslo P&P	25
Initial installation	26
Maintenance	30
Jet Directions	
Lugano Life	31
Vienna Life	32
Malaga Life	33
Lima Life	34
Prague Life	35
Manhattan Life	36
Milano P&P	37
Oslo P&P	38
Keypad functions	39
User interface - in.k300	50
Other accessories - The Heat Pump (optional)	53
Smart step manual (optional)	57
Other accessories	
Ozone	72
in.grid	73
in.touch 2	74
Wellis Spa Control	79
Wiring diagram - W2000, W2001	98
Wiring diagram - W3000	104
Breaker setting	108
Power up	109
Common hardware issues	110

INTRODUCTION

Congratulations on your new product!

Outside of work and family, the enjoyment of quality life and calm moments plays an important role in the life of a 21st century person. An evening soak in the hot tub or tub alone or with company can allow you to lose track of time and your body and soul can relax. From the world of rationality, we get into the world of senses where the calming atmosphere of the water provides the perfect conditions for relaxation.

Our design engineers utilized the experiences of the ancient Eastern massage and the modern findings of Western hydrotherapy to create hot tubs providing the perfect massage experience.

Develop a peaceful space for relaxation with your product in your home and join the group of the few who seek a positive impact on their environment by establishing internal harmony.

Ease into your hot tub and enjoy the gently flowing water!

Aeware®, Gecko®, and their respective logos are Registered Trademarks of Gecko Alliance Group. in.yt™, in.ye™, in.yj™, in.touch™, in.stream 2™, DJS™, in.k110™, in.k120™, in.k361™, in.k1001™, in.clear™, and their respective logos are Trademarks of Gecko Alliance Group.

All other product or company names that may be mentioned in this publication are tradenames, trademarks or registered trademarks of their respective owners.

IMPORTANT SAFETY INSTRUCTIONS

1. **READ AND FOLLOW ALL INSTRUCTIONS.**
2. **WARNING** – To reduce the risk of injury, do not permit children to use this product unless they are closely always supervised.
3. A wire connector is provided on this unit to connect a minimum 8 AWG (8.4 mm²) solid copper conductor between this unit and any metal equipment, metal enclosures of electrical equipment, metal water pipe, or conduit within 5 feet (1.5 m) of the unit.
4. (For cord-connected/convertible units) **DANGER** – Risk of injury.
 - a) Replace damaged cord immediately.
 - b) Do not bury cord.
 - c) Connect to a grounded, grounding type receptacle only.
5. **DANGER** – Risk of Accidental Drowning. Extreme caution must be exercised to prevent unauthorized access by children. To avoid accidents, ensure that children cannot use this hot tub unless they are supervised at all times.
6. **DANGER** – Risk of Injury. The suction fittings in this hot tub are sized to match the specific water flow created by the pump. Should the need arise to replace the suction fittings or the pump, be sure that the flow rates are compatible.
Never operate hot tub if the suction fittings are broken or missing. Never replace a suction fitting with one rated less than the flow rate marked on the original suction fitting.
7. **DANGER** – Risk of Electric Shock. Install at least 5 feet (1.5 m) from all metal surfaces. As an alternative, a hot tub may be installed within 5 feet of metal surfaces if each metal surface is permanently connected by a minimum 8 AWG (8.4 mm²) solid copper conductor to the wire connector on the terminal box that is provided for this purpose.
8. **DANGER** – Risk of Electric Shock. Do not permit any electric appliance, such as a light, telephone, radio, or television, within 5 feet (1.5 m) of a hot tub.
9. **WARNING** – To reduce the risk of injury:
 - a) The water in a hot tub should never exceed 40°C (104°F). Water temperatures between 38°C (100°F) and 40°C are considered safe for a healthy adult. Lower water temperatures are recommended for young children and when hot tub use exceeds 10 minutes.
 - b) Since excessive water temperatures have a high potential for causing fetal damage during the early months of pregnancy, pregnant or possibly pregnant women should limit hot tub water temperatures to 38°C (100°F).
 - c) Before entering a hot tub, the user should measure the water temperature since the tolerance of water temperature-regulating devices varies.
 - d) The use of alcohol, drugs, or medication before or during hot tub use may lead to unconsciousness with the possibility of drowning.
 - e) Obese persons and persons with a history of heart disease, low or high blood pressure, circulatory system problems, or diabetes should consult a physician before using a hot tub.
 - f) Persons using medication should consult a physician before using a hot tub since some medication may induce drowsiness while other medication may affect heart rate, blood pressure, and circulation.

13. SAVE THESE INSTRUCTIONS.

Audio/video components

- a) CAUTION – Risk of Electric Shock. Do not leave compartment door open.
- b) CAUTION – Risk of Electric Shock. Replace components only with identical components.
- c) Do not operate the audio/video controls while inside in the hot tub.
- d) WARNING – Prevent Electrocutation. Do not connect any auxiliary components (for example cable, additional speakers, headphones, additional audio/video components, etc.) to the system.
- e) These units are not provided with an outdoor antennae; when provided, it should be installed in accordance with Article 810 of the National Electrical Code, ANSI/NFPA 70.
- f) Do not service this product yourself as opening or removing covers may expose you to dangerous voltage or other risk of injury. Refer all servicing to qualified service personnel.
- g) When the power supply connections or power supply cord(s) are damaged; if water is entering the audio/video compartment or any electrical equipment compartment area; if the protective shields or barriers are showing signs of deterioration; or if there are signs of other potential damage to the unit, turn off the unit and refer servicing to a qualified service personnel.
- h) This unit should be subjected to periodic routine maintenance (for example, once every 3 months) to make sure that the unit is operating properly.

FOR YOUR SAFETY PLEASE ALWAYS PERFORM THE FOLLOWING PRECAUTIONS. IF YOU DO NOT FOLLOW THE WARNINGS AND INSTRUCTIONS, ITEMS MAY GET DAMAGED, YOU MAY GET INJURED, OR YOU MAY SUFFER FATAL INJURY. IMPROPER INSTALLATION AND OPERATION INVALIDATES THE WARRANTY. AVOIDING THE RISK TO CHILDREN

- To reduce the risk of injury, lower water temperatures are recommended for young children. Children are especially sensitive to hot water.
- Extreme caution must be exercised to prevent unauthorized access by children. To avoid accidents, ensure that children cannot use a hot tub unless they are supervised at all times.

DO:

- Make sure you always lock the child resistant locks after using the hot tub for your children's safety.
- Test the water temperature with your hand, or a thermometer before allowing children to enter the hot tub to be sure that it's comfortable. Children are especially sensitive to hot water.
- Remind children that wet surfaces can be very slippery. Make sure that children are careful when entering or exiting the hot tub.
- Do not allow children to climb onto the hot tub cover.
- Do not allow children to have unsupervised access to the hot tub.

SAFETY INSTRUCTIONS

AVOIDING THE RISK OF ELECTROCUTION



DANGER - RISK OF ELECTROCUTION

Initial safety warnings

- The hot tub must be powered through a residual current device (rCD) with a current release not exceeding 30mA.
- The devices and parts which contain active parts – except those which are powered from protective extra low voltage not exceeding 12V – must be inaccessible from the hot tub.
- Connect only to a grounded source.
- Do not bury the power cord. A buried power cord may result in death, or serious personal injury due to electrocution if direct burial-type cable is not used, or if improper digging occurs.



WARNING

- To reduce the risk of electrical shock, replace a damaged cord immediately. Failure to do so may result in death or serious personal injury due to electrocution.
- Your hot tub must be connected to a Ground Fault Circuit Interrupter (GFCI) for user and equipment protection. To ensure proper operation of this important safety device, test according to the following instructions per electrical configuration.
- **Cord-Connected 115 volt, 20 amp models:** The GFCI is located at the end of the power cord. Before each use, with the unit operating, push the TEST button. The unit should stop operating and the GFCI power indicator will go out. Wait 30 seconds and then reset the GFCI by pushing the RESET button. The GFCI power indicator will turn on, restoring power to the hot tub. If the interrupter does not perform in this manner, there

may be an electrical malfunction and with it, the possibility of an electric shock. Disconnect the power until the problem has been corrected.

- **2x120 volt, permanently connected or converted models:**
- A ground terminal is provided on the terminal block (TB-1, system ground terminal) located inside the control box. To reduce the risk of electric shock, connect this terminal to the grounding terminal of your electrical service or supply panel with a continuous green, insulated copper wire. The wire must be equivalent in size to the circuit conductors supplying the equipment. In addition, a bonding terminal (pressure wire connector) is provided on the outside of the control box for bonding to local ground points. To reduce the risk of electric shock, this connector should be bonded with a No. 8 AWG (8.4 mm²) solid copper wire to any metal ladders, water pipes, or other metal within 5 feet (1.5 m) of the hot tub to comply with local requirements. The means of disconnection must be readily accessible, but must be installed at least 5 feet (1.5 m) from the hot tub.
- Your hot tub is provided with a suitably rated circuit breaker to open all ungrounded supply conductors.
- Your hot tub uses ground fault circuit interrupters in the electrical sub-panel. Before each use of the hot tub and with the unit operating, push the TEST button on each breaker. The switch should click over to the “Trip” position. Wait 30 seconds and reset each GFCI breaker by switching it completely off and then completely on.

The switch should then stay on. If either of the interrupters does not perform in this manner, it is an indication of an electrical malfunction and the possibility of an electric shock. Disconnect the power until the fault has been identified and corrected.

SAFETY INSTRUCTIONS

IMPORTANT: Failure to wait 30 seconds before resetting the GFCI may cause the hot tub's Power Indicator (on the control panel) to blink. If this occurs, repeat the GFCI test procedure.



DANGER - RISK OF ELECTRIC SHOCK

- A wire connector is provided on this unit to connect a minimum 8 AWG (8.4 mm²) solid copper conductor between this unit and any metal equipment, metal enclosures of electrical equipment, metal water pipe, or conduit within 5 feet (1.5 m) of the unit.
- Install at least 5 feet (1.5 m) from all metal surfaces. As an alternative, a hot tub may be installed within 5 feet of metal surfaces if each metal surface is permanently connected by a minimum 8 AWG (8.4 mm²) solid copper conductor to the wire connector on the terminal box that is provided for this purpose.
- Do not permit any electric appliance, such as a light, telephone, radio, or television, within 5 feet (1.5 m) of a hot tub. Failure to maintain a safe distance may result in death, or serious personal injury due to electrocution, if the appliance should fall into the hot tub.
- Install your hot tub in such a way that drainage is away from the electrical compartment and from all electrical components.
- **CAUTION** — Risk of Electric Shock. Do not leave compartment door open
- **CAUTION** — Risk of Electric Shock. Replace components only with identical components
- Do not service this product yourself as opening or removing covers may expose you to dangerous voltage or other risk of injury. Refer all servicing to qualified service personnel.

DO:

- Be sure your hot tub is connected to the power supply correctly - use a licensed electrical contractor.
- Disconnect the hot tub from the power supply before draining the hot tub or servicing the electrical components.
- Test the Ground Fault Circuit Interrupter(s) before each use.
- Do not use the hot tub with the equipment compartment door removed.
- Do not place electrical appliances within 5 feet (1.5m) of the hot tub.
- Do not use an extension cord to connect the hot tub to its power source. The cord may not be properly grounded and the connection is a shock hazard. An extension cord may cause a voltage drop, which will cause overheating of the jet pump motor and motor damage.
- Do not attempt to open the electrical control box. There are no user serviceable parts inside.

RISKS TO AVOID



DANGER - RISK OF INJURY

- To reduce the risk of injury to persons, **DO NOT** remove suction fittings (filter standpipes) located in the filter compartment.
- There is a danger of slipping and falling. Remember that wet surfaces can be very slippery. Take care when entering or exiting the hot tub.
- Never operate hot tub if the suction fittings are broken or missing.
- People with infectious diseases should not use the hot tub.
- Keep any loose articles of clothing, long hair, or hanging jewelry away from rotating jets or other moving components.

SAFETY INSTRUCTIONS

- Water treatment should be carried out with caution. Improperly chemically treated water may cause skin irritation.
- Do not remove any suction fittings.
- Do not operate the hot tub if the suction fittings is broken or missing.
- Keep your clothes and jewelry away from rotating jets and moving parts.
- Effects of overheating: you cannot assess emergency situations, do not feel the temperature, do not feel the need to get out of the hot tub, physically cannot get out of the hot tub; risk of fetal damage in pregnant women, loss of consciousness, suffocation.
- Do not use the hot tub alone.
- Do not use the hot tub immediately after strenuous sport.

INCREASED SIDE EFFECTS OF MEDICATION

- The use of drugs, alcohol may cause unconsciousness with the possibility of drowning.

HEALTH PROBLEMS AFFECTED BY HOT TUB USE

- Pregnant women should consult a physician before using hot tub.
- Obese persons and persons with a history of heart disease, low or high blood pressure, circulatory system problems, or diabetes should consult a physician before using a hot tub.

AVOIDING THE RISK OF HYPERTHERMIA

Prolonged immersion in hot water can result in HYPERTHERMIA. Hyperthermia occurs when the internal temperature of the body reaches a level several degrees above the normal body temperature of 98.6°F. The symptoms of hyperthermia include an increase in the internal temperature of the body, dizziness, lethargy, drowsiness, and fainting. The effects of

hyperthermia include failure to perceive heat; failure to recognize the need to exit hot tub; unawareness of impending hazard; fetal damage in pregnant women; physical inability to exit the hot tub; and unconsciousness resulting in the danger of drowning.



WARNING

The use of alcohol, drugs, or medication before or during hot tub use may lead to unconsciousness with the possibility of drowning.

TO REDUCE THE RISK OF INJURY

- The water in a hot tub should never exceed 40°C (104°F). Water temperatures between 38°C (100°F) and 40°C are considered safe for a healthy adult. Lower water temperatures are recommended for young children and when hot tub use exceeds 10 minutes. Extended use can cause hyperthermia.
- Since excessive water temperatures have a high potential for causing fetal damage during the early months of pregnancy, pregnant or possibly pregnant women should limit hot tub water temperatures to 38°C (100°F).
- Pregnant or possibly pregnant women should limit hot tub water temperatures to 100°F (36°C). Failure to do so may result in permanent injury to your baby.
- Do not use hot tub immediately following strenuous exercise.
- Obese persons and persons with a history of heart disease, low or high blood pressure, circulatory system problems, or diabetes should consult a physician before using a hot tub.

SAFETY INSTRUCTIONS

AVOIDING THE RISK OF SKIN BURNS

- Before entering a hot tub, the user should measure the water temperature since the tolerance of water temperature-regulating devices varies.
- To reduce the risk of injury, before entering a hot tub the user should measure the water temperature with an accurate thermometer.
- Test the water with your hand before entering the hot tub to be sure it's comfortable.

PRODUCT SAFETY AND MAINTENANCE

For units intended for use in other than single-family dwellings, a clearly labeled emergency switch must be provided as part of the installation. The switch must be readily accessible to the occupants and must be installed at least 5 feet (1.52 m) away, adjacent to, and within sight of, the unit.

When the hot tub is not in use, cover the hot tub with the cover to prevent ultraviolet radiation causing damage to the product.

Do not remove any suction fitting. Do not operate the hot tub if the suction fitting is broken or missing.

Keep your clothes and jewelry away from rotating jets and moving parts.

Test the residual current device before use.

Disconnect the hot tub from the power supply before servicing its electrical parts. (This operation can only be performed by qualified professionals).

It is strictly prohibited to use the hot tub in a not completely assembled state (e.g. detached side panel)

Chemical treatment of water can only be performed by persons under the age of 18 under parental supervision.

Maintenance can only be performed by trained professionals.

The user should check the electrical wiring

every 3 months. It is required to perform a check by a professional every 3 years.

Mains, fuses, and circuit breakers may be activated because of power outages.

Installation and wiring of the hot tub, replacement of power cord, and any repairs must be performed by qualified professionals.

It is required to build in an isolating device to the fixed wiring.

PLUG'N PLAY SAFETY WARNINGS BEYOND THE PREVIOUS WARNINGS, PLEASE ALSO PAY ATTENTION TO THE UNDERMENTIONED ONES.

***ATTENTION!** The electrical receptacle must be located at least 2.5 meters (8 feet) from the hot tub so that bathers in a sitting position cannot reach it from the water. The plug can only be connected to a receptacle equipped with 2.5 mm 2 diameter cables.*

***ATTENTION! RISK OF ELECTRIC SHOCK.** The connector with residual current device must be inspected before every use.*

***ATTENTION!** Only place the RCD plug in a receptacle equipped with RCD.*

***ATTENTION!** Before you insert the plug into the socket ensure that the current of the socket and the fixed wiring is appropriate for the properties of the hot tub.*

The hot tub must be equipped with an isolation transformer or powered through a residual current device with a release current not exceeding 30mA.

This product is equipped with a ground fault circuit breaker (GFCI) in the connector. GFCI must be tested before each use.

If the power cable is damaged, it must immediately be replaced by the manufacturer or a service professional in order to minimize danger.

SAFETY INSTRUCTIONS

To minimize the risk of electric shock do not use extension leads to connect the product to the power supply.

Ensure that the receptacle is properly located.

Parts of the equipment cannot be placed above the hot tub during usage.

Parts under electrical power – except those operating with voltage not exceeding 12V - must be inaccessible for persons in the hot tub. The grounded device must be connected to a fixed socket with fixed wiring. Electrical parts – except remote controllers – must be positioned so as not to fall into the hot tub.

The electrical installation must meet the local standard requirements.

To avoid electric shock do not use the hot tub in rain.

Water attracts children. Always place and lock the cover on the hot tub after each usage.

Do not bury cables into the ground! Place the cables so that lawnmowers, trimmers, and similar devices will not reach them.

Do not force push the control panel up nor down and do not place heavy objects on it after installation.

Keep pets away from the hot tub to avoid damage.

Do not use the device if there is the slightest chance of water in the hot tub being frozen.

Only use accessories approved by us. The use of accessories not approved by us may void the warranty.

Choking hazard. Particular attention need to be paid to children during usage. To avoid accidents only allow children to use this hot tub under adult supervision.

To prevent damage to the pump the hot tub can only be operated if it has been filled with water.

If you feel uncomfortably or sleepy, leave the hot tub immediately.

Never add water to the chemicals. Always be cautious when adding chemicals to the hot tub water to avoid inhaling vapors and possible effects of inhaling undiluted chemicals and splatters.

Only place the hot tub on a surface that can support its weight.

Inspect the unit before use. contact the service provider stated in this manual if any of the parts were damaged or missing upon purchase. Ensure that the parts of the unit are those which you intended to buy.

In.clear safety warnings

Beyond the previous warnings, please also pay attention to the undermentioned ones read this manual carefully, always follow its instructions, and retain it. This manual contains important information about the installation, operation, and safety recommendations of the in.clear unit. Safe installation and usage is your responsibility.

The in.clear unit must be connected to a network protected by a ground fault circuit interrupter (GFCI) of the maximal nominal fault current value of 30mA.

Ensure that the entire power supply is turned off before the in.clear unit is installed.

If the power cord is damaged, it must be replaced by the manufacturer, an authorized service provider, or qualified professionals to avoid emergencies.

Always use a proper electric cable for supply of current to the in.clear unit.

When installing the in.clear Automatic Bromine Generator local and international electrical regulations must be complied with.

Clean or replace the filter cartridge at regular intervals, otherwise part of the bromine produced by the in.clear unit will be consumed by oxidation of contamination accumulated in the filter.

DO NOT pour any other chemicals into the hot tub than the recommended sodium bromide.
DO NOT use any ozone or UV disinfectant.

Operating the in.clear unit on lower sodium bromide level shortens the life of the cells. Keeping sodium bromide and bromine levels above the recommended level may lead to corrosion of the hot tub components and cause damage to the hot tub accessories.

Do not open the in.clear unit; it does not contain serviceable parts

Product disposal: the in.clear unit must be disposed of in accordance with local disposal regulations in force.

This device is not intended for use by persons (nor children) with limited physical, sensory, or mental capabilities except if these persons have received appropriate instruction on use of the device from the person responsible for their safety.

The in.clear unit cannot be applied to in-ground sunken hot tubs as it may affect materials used in the construction.

The shut-off device must have fixed wiring in accordance with the cabling regulations.

Showering is compulsory before each hot tub use.

The user is responsible for regular monitoring of the hot tub water to ensure that enough bromine is available to reach the appropriate cleaning level. Intensive hot tub use may require higher bromine intake to always maintain appropriate bromine level.

Always check the expiry date of the test kit, because after this date the test results may be inaccurate.

For proper disinfection hot tubs must periodically be completely drained. The advised time period between full drains given in days is calculated by dividing the capacity of the hot tub in liters by the tenfold of the average daily users.

The in.clear unit is applicable for indoor hot tubs, but NOT for swimming pools.

THIS UNIT SHOULD BE SUBJECTED TO PERIODIC ROUTINE MAINTENANCE (FOR EXAMPLE, ONCE EVERY 3 MONTHS) TO MAKE SURE THAT THE UNIT IS OPERATING PROPERLY.

SAVE THESE INSTRUCTIONS

WARNING: CHILDREN SHOULD NOT USE HOT TUBS OR HOT TUBS WITHOUT ADULT SUPERVISION

AVERTISSEMENT : NE PAS LAISSER LES ENFANTS UTILISER UNE CUVE DE RELAXATION SANS SURVEILLANCE

WARNING: DO NOT USE HOT TUBS OR HOT TUBS UNLESS ALL SUCTION GUARDS ARE INSTALLED TO PREVENT BODY AND HAIR ENTRAPMENT

AVERTISSEMENT : POUR ÉVITER QUE LES CHEVEUX OU UNE PARTIE DU CORPS PUISSENT ÊTRE ASPIRÉS, NE PAS UTILISER UNE CUVE DE RELAXATION SI LES GRILLES DE PRISE D'ASPIRATION NE SONT PAS TOUTES EN PLACE

WARNING: PEOPLE USING MEDICATIONS AND/OR HAVING AN ADVERSE MEDICAL HISTORY SHOULD CONSULT A PHYSICIAN BEFORE USING A HOT TUB

AVERTISSEMENT : LES PERSONNES QUI PRENNENT DES MÉDICAMENTS ET (OU) ONT DES PROBLÈMES DE SANTÉ DEVRAIENT CONSULTER UN MÉDECIN AVANT D'UTILISER UNE CUVE DE RELAXATION

WARNING: PEOPLE WITH INFECTIOUS DISEASES SHOULD NOT USE A HOT TUB

AVERTISSEMENT : LES PERSONNES ATTEINTES DE MALADIES INFEC-

SAFETY INSTRUCTIONS - CANADA

TIEUSES NE DEVRAIENT PAS UTILISER UNE CUVE DE RELAXATION

WARNING: TO AVOID INJURY, EXERCISE CARE WHEN ENTERING OR EXITING THE HOT TUB

AVERTISSEMENT : POUR ÉVITER DES BLESSURES, USER DE PRUDENCE EN ENTRANT DANS UNE CUVE DE RELAXATION ET EN SORTANT

WARNING: DO NOT USE DRUGS OR ALCOHOL BEFORE OR DURING THE USE OF A HOT TUB TO AVOID UNCONSCIOUSNESS AND POSSIBLE DROWNING

AVERTISSEMENT : POUR ÉVITER L'ÉVANOUISSEMENT ET LA NOYADE ÉVENTUELLE, NE PRENDRE NI DROGUE NI ALCOOL AVANT D'UTILISER UNE CUVE DE RELAXATION NI QUAND ON S'Y TROUVE

WARNING: PREGNANT OR POSSIBLY PREGNANT WOMEN SHOULD CONSULT A PHYSICIAN BEFORE USING A HOT TUB

AVERTISSEMENT : LES FEMMES ENCEINTES, QUE LEUR GROSSESSE SOIT CONFIRMÉE OU NON, DEVRAIENT CONSULTER UN MÉDECIN AVANT D'UTILISER UNE CUVE DE RELAXATION

WARNING: WATER TEMPERATURE IN EXCESS OF 38 °C CAN BE INJURIOUS TO YOUR HEALTH

AVERTISSEMENT : IL PEUT ÊTRE DANGEREUX POUR LA SANTÉ DE SE PLONGER DANS DE L'EAU À PLUS DE 38 °C

WARNING: BEFORE ENTERING THE HOT TUB, MEASURE THE WATER TEMPERATURE WITH AN ACCURATE THERMOMETER

AVERTISSEMENT : AVANT D'UTILISER UNE CUVE DE RELAXATION, MESURER LA TEMPÉRATURE

DE L'EAU À L'AIDE D'UN THERMOMÈTRE PRÉCIS

WARNING: DO NOT USE A HOT TUB IMMEDIATELY FOLLOWING STRENUOUS EXERCISE

AVERTISSEMENT : NE PAS UTILISER UNE CUVE DE RELAXATION IMMÉDIATEMENT APRÈS UN EXERCICE FATIGANT

WARNING: PROLONGED IMMERSION IN A HOT TUB CAN BE HAZARDOUS TO YOUR HEALTH

AVERTISSEMENT : L'UTILISATION PROLONGÉE D'UNE CUVE DE RELAXATION PEUT ÊTRE DANGEREUSE POUR LA SANTÉ

WARNING: DO NOT PERMIT ELECTRIC APPLIANCES (SUCH AS A LIGHT, TELEPHONE, RADIO, OR TELEVISION) WITHIN 1.5 M OF THIS SPA OR HOT TUB

AVERTISSEMENT : NE PAS PLACER D'APPAREIL ÉLECTRIQUE (LUMINAIRE, TÉLÉPHONE, RADIO, TÉLÉVISEUR, ETC) À MOINS DE 1.5 M DE CETTE CUVE DE RELAXATION

CAUTION : MAINTAIN WATER CHEMISTRY IN ACCORDANCE WITH MANUFACTURER'S INSTRUCTIONS

ATTENTION: LA TENEUR DE L'EAU EN MATIÈRES DISSOUTES DOIT ÊTRE CONFORME AUX DIRECTIVES DU FABRICANT.

WARNING: THE USE OF ALCOHOL OR DRUGS CAN GREATLY INCREASE THE RISK OF FATAL HYPERTHERMIA IN HOT TUBS AND SPAS

LA CONSOMMATION D'ALCOOL OU DE DROGUE AUGMENTE CONSIDÉRABLEMENT LES RISQUES D'HYPERTHERMIE MORTELLE DANS UNE CUVE DE RELAXATION.

SAFETY INSTRUCTIONS - CANADA

WARNING: RISK OF ACCIDENTAL DROWNING. EXTREME CAUTION MUST BE EXERCISED TO PREVENT UNAUTHORIZED ACCESS. ENSURE THAT CHILDREN CANNOT USE THIS PRODUCT UNLESS THEY ARE SUPERVISED AT ALL TIMES

AVERTISSEMENT : RISQUE DE NOYADE. PRENDRE TOUTES LES PRÉCAUTIONS NÉCESSAIRES POUR INTERDIRE L'ACCÈS AUX PERSONNES NON AUTORISÉES. S'ASSURER QUE LES ENFANTS NE PUISSENT PAS UTILISER CE PRODUIT SANS SURVEILLANCE CONSTANTE

WARNING: RISK OF ACCIDENTAL DROWNING. THE USE OF ALCOHOLIC BEVERAGES OR DRUGS BEFORE OR DURING HOT TUB USE CAN LEAD TO UNCONSCIOUSNESS WITH THE POSSIBILITY OF DROWNING

AVERTISSEMENT : RISQUE DE NOYADE. TOUTE PERSONNE QUI PREND DE LA DROGUE OU DE L'ALCOOL AVANT D'UTILISER UNE CUVE DE RELAXATION OU PENDANT QU'ELLE S'Y TROUVE RISQUE L'ÉVAUOISEMENT ET LA NOYADE

WARNING: RISK OF ACCIDENTAL DROWNING DUE TO HYPERTHER-

MIA. CONSULT THE INSTRUCTIONS PROVIDED WITH THIS UNIT FOR A DESCRIPTION OF THE CAUSES, SYMPTOMS, AND EFFECTS OF HYPERTHERMIA

AVERTISSEMENT : RISQUE DE NOYADE PAR SUITE D'HYPERTHERMIE. LIRE LA NOTICE QUI ACCOMPAGNE

CET APPAREIL; ELLE DÉCRIT LES CAUSES, LES SYMPTÔMES ET LES EFFETS DE L'HYPERTHERMIE

WARNING: RISK OF ELECTRIC SHOCK. DO NOT PERMIT ANY ELECTRIC APPLIANCE (SUCH AS A LIGHT, TELEPHONE, RADIO, OR TELEVISION) WITHIN 1.5 M OF A HOT TUB

AVERTISSEMENT : DANGER D'ÉLECTROCUTION. NE PAS PLACER D'APPAREIL ÉLECTRIQUE (LUMIÉRE, TÉLÉPHONE, RADIO, TÉLÉVISEUR, ETC) À MOINS DE 1.5 M DE CETTE CUVE DE RELAXATION

WARNING: THIS MARKING SHALL BE REMOVED BY THE END USER OF THIS PRODUCT ONLY

AVERTISSEMENT : SEUL L'UTILISATEUR DE CE PRODUIT PEUT ENLEVER CE MARQUAGE.

IMPORTANT SAFETY INSTRUCTIONS

When using this electrical equipment, basic safety precautions should always be followed, including the following:

- A) **READ AND FOLLOW ALL INSTRUCTIONS.**
- B) A GREEN COLORED TERMINAL OR A TERMINAL MARKED G, GR, GROUND, GROUNDING, OR THE Ⓧ SYMBOL IS LOCATED INSIDE THE SUPPLY TERMINAL BOX OR COMPARTMENT. TO REDUCE THE RISK OF ELECTRIC SHOCK, THIS TERMINAL MUST BE CONNECTED TO THE GROUNDING MEANS PROVIDED IN THE ELECTRIC SUPPLY SERVICE PANEL WITH A CONTINUOUS COPPER WIRE EQUIVALENT IN SIZE TO THE CIRCUIT CONDUCTORS SUPPLYING THIS EQUIPMENT.
- C) AT LEAST TWO LUGS MARKED “BONDING LUGS” ARE PROVIDED ON THE EXTERNAL SURFACE OR ON THE INSIDE OF THE SUPPLY TERMINAL BOX OR COMPARTMENT. TO REDUCE THE RISK OF ELECTRIC SHOCK, PER CODE, USE OF A LOCAL COMMON BONDING GRID IS NOT NECESSARY FOR PORTABLE HOT TUBS OR SWIM SPAS.
- D) ALL FIELD-INSTALLED METAL COMPONENTS SUCH AS RAILS, LADDERS, DRAINS, OR OTHER SIMILAR HARDWARE WITHIN 3 M OF THE SPA OR HOT TUB SHALL BE BONDED TO THE EQUIPMENT GROUNDING BUS WITH COPPER CONDUCTORS NOT SMALLER THAN NO. 6 AWG.

E) **SAVE THESE INSTRUCTIONS.**

F) **DISTINGUISHING BETWEEN P&P AND NON P&P INSTALLATION:**

IT'S IMPORTANT TO DIFFERENTIATE BETWEEN PLUG & PLAY (P&P) AND NON PLUG & PLAY (NON P&P) INSTALLATION METHODS AS THEY IMPACT THE SETUP OF THE HOT TUB, PARTICULARLY REGARDING THE SECURING OF THE HOT TUB AND THE PLACEMENT OF WIRES.

NON P&P INSTALLATION:

IN CASES WHERE THE HOT TUB IS NOT SET UP AS A PLUG & PLAY SYSTEM, IT IS NECESSARY TO SECURE THE HOT TUB TO PREVENT THE POWER CORD FROM MECHANICAL DAMAGE. THIS IS PARTICULARLY CRUCIAL IF THE HOT TUB IS INSTALLED AT GROUND LEVEL.

THE MOVEMENT OF THE HOT TUB CONSTITUTES A REINSTALL IN EVERY CASE, PLEASE ENSURE THAT THE HOT TUB CANNOT MOVE.

BASIC FUNCTIONS

Keypads: The keypads make it possible to control and set up the spa. Available basic functions: pump(s), light and temperature control. (For more information please read this owner's manual)

Valves

Diverter: Some spas are equipped with water diverter(s) that allows you to direct the waterflow to various sections of the spa. The valve has three basic positions turning the lever all the way to the left position will divert the water section A of the spa. Turning the lever all the way to the right will shut off section A and divert the water to section B and by moving the lever to the middle between A & B will divert the water to both A & B sections

Waterfall diverter: Some spas are equipped with a waterfall diverter which will turn the waterfalls/fountains either on or off

Air regulators: You can use it by turning the lever counter-clockwise, will open the Air Regulator to allow air to mix with the water to create more pressure from the jets. Turning the lever to the left will close the valve not allowing air to mix with the water for the jets. These air regulators should remain closed when the spa is not in use to save energy.

Speakers (Optional): If your spa is equipped with an audio system, you can connect via Bluetooth and help your relaxing with your favorite music. (MyMusic pin:2288)

Filter house: Part of the recirculating system, it holds the paper filter.

Fountain: Some spas are equipped with fountains or waterfalls. If you open the waterfall diverter, the water will flow through the fountains or waterfalls.

Jets: There are 3 sizes of jets; the 5" and 3" jets have two types: directional and rotational. The 2" jets are only directional. To open the jet face is turned clockwise. To lessen the pressure or to close, the jet face is turned counter-clockwise

Aroma therapy (optional equipment): You can stimulate your senses with different aromas. You can inject aroma into the water if you push the button on the top of the tank. You can lock the button if you turn it.

Suction: The pumps pulls water through these fittings. Never block it, and keep your body and hair away from these units.

Head rests



Keypads



Diverter, Air regulator, On/off valve



Speakers



Filter house



Fountain



Jet (5"-direct, rotational; 3"-direct, rotational; 2"-direct)



Aroma



Suction



Instructions for Reading the Code on the Data Card:

Locate the data card on your spa, usually situated beneath the side panel, typically on the same side as the control panel. Utilize the table provided on the following page to determine the spa specification.

Example of data card:

MODEL	Libra
TYPE	WM2AQBCEDBK2****W1MNE**NNNN
INTERNAL ORD. NR SERIAL NUMBER	SPA 631937 WM00740-2158
DATE CODE	16/08/2024
RATING MINIMUM SUPPLY AMPACITY	8,4kW 240V 60Hz 37A
MAXIMUM FLOW RATE	1420 l/min
AMPER RATING OF SUPPLY CONDUCTOR PROTECTION DEVICE	50A
FOR INDOOR/OUTDOOR USE CSA Enclosure type 3	MANUFACTURER Hungary-3600, Ózd belterület hrsz: 9104. 

MODEL	Oslo P&P
TYPE	WM1A*GDBCAA1*****MNE**NNNP
INTERNAL ORD. NR SERIAL NUMBER	SPA *113583 11/6 WM00710-540
DATE CODE	01/08/2024
RATING MINIMUM SUPPLY AMPACITY	1,2kW 120V 60Hz 12A
MAXIMUM FLOW RATE	460 l/min
AMPER RATING OF SUPPLY CONDUCTOR PROTECTION DEVICE	15A
FOR INDOOR/OUTDOOR USE CSA Enclosure type 3	MANUFACTURER Hungary-3600, Ózd belterület hrsz: 9104. 

WM2ARDCACBG1****W1NO*L*WEWN

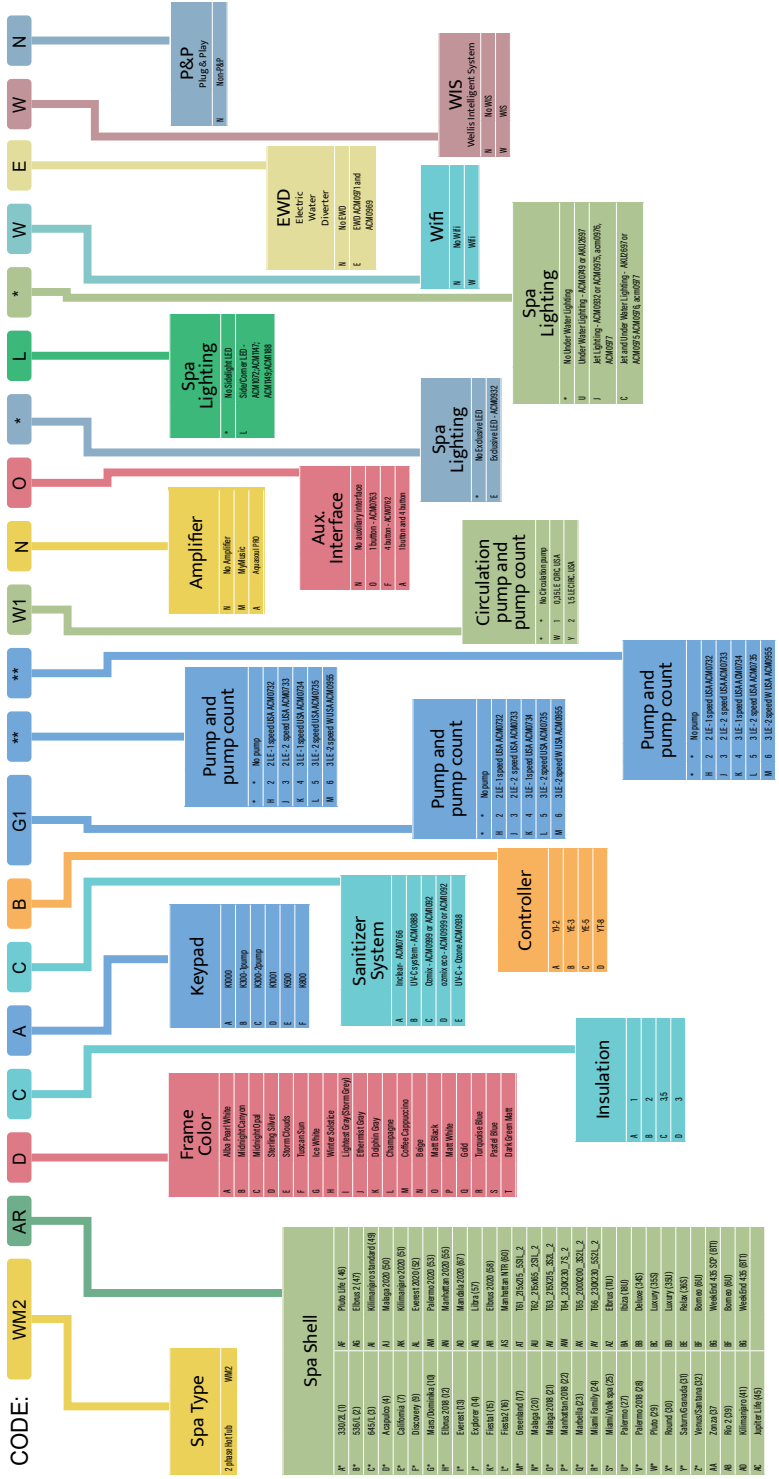

CONNECTION DIAGRAM

LUGANO LIFE

No.	Art. No.	iFS name	Pcs.
1	ACM0959	Control Panel- INL500 GRC/KO	1
2	ACM0734	Spa Pump 3 HP - One Speed 60 Hz	1
3	ACM0734	Spa Pump 3 HP - One Speed 60 Hz	F
4	AKU2647	Led housing with seal	13
5	AKU1892	Af Regulator - house led lighted V2	4
6	AKU1891	Water Diverter 60 - LED lighted V2	1
7	AKU0056	Cup Holder Light lens light bulb/transparent	2
8	AKU2607	RD Suction 2' with gasket	4
9	AJ00214	Jet 2' - transparent 1 Hole transparent V3 Wells	23
10	AJ00216	Jet 3' - transparent 1 Hole V3 Wells	23
11	AJ00218	Jet 5' - transparent 1 Hole transparent V3 Wells	6
12	AKU1893	On-Off tap house 33 transparent V2	1
13	AKU1894	Water Diverter - Grip Wells V2	1
14	AKU1895	Af regulator grip Wells V2	4
15	AKU1896	On-off tap grip Wells V2	1
16	AR00065	Flow 4x217 grey (ROB) light grey	3
17	AKU1833	Filler House - Skimmer Cover grey with Wells logo	1
18	AKU1835	Skimmer house light grey	1
19	AKU1609	Spa Filter - 175 * 152 - Myline white (coarse thread)	3
20	AKU2437	Cup Holder Light - lens wells 2020	2
21	AJ00248	Cup Holder Light nut	2
22	AJ00291	Jet ozone with sealing V2	1
23	AJ00292	Ozone nut self-aligning V2	1
24	AKU0084	Water Drain - 20 RB V2	1
25	ACM0854	Control box in: ES	1
26	ABE0621	Ozon mixer - Housing	1
27	ABE0620	Mixer housing	1
28	AJ00282	Jet water circulation self-levelling medium gray for life	1
29	AKU1840	Filter holder - 48 mm	3
30	ACM0825	Galle for speaker 3" (2 way)	2
31	ACM0824	Speaker 3" (2 way)	2
32	ACM0902	Circulation pump WTC50M 250 W 60Hz	1

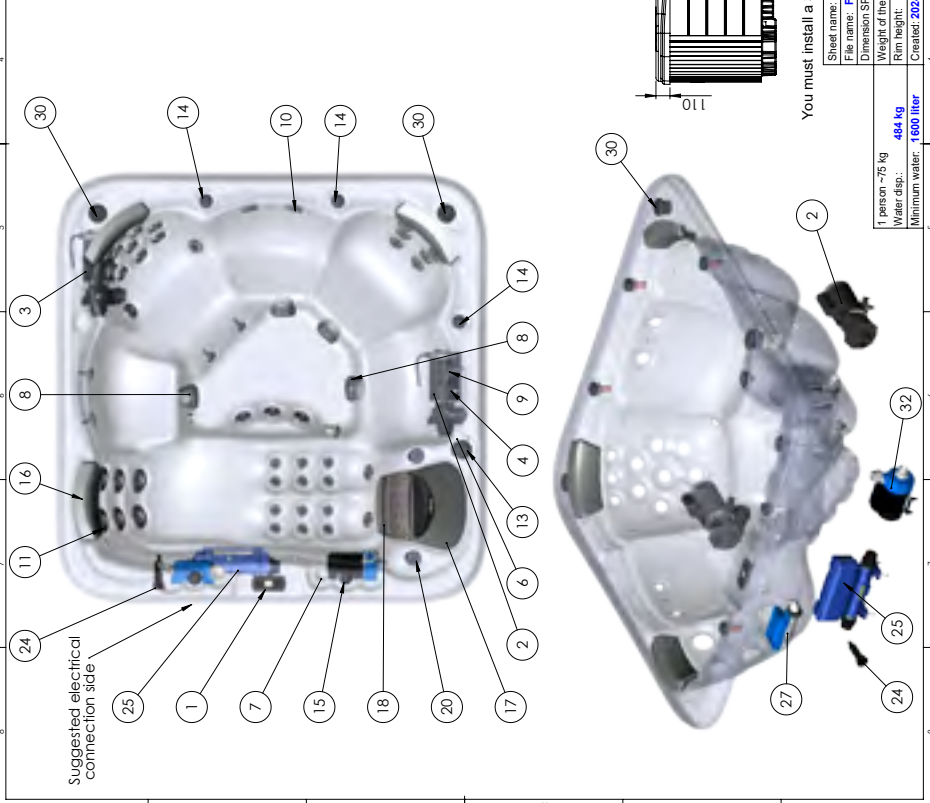

Suggested electrical connection side

You must install a 30 mA residual-current device (RCD).

Sheet name: Lugano Life USA ENG		Product family: WelliaCityLife	
File name: EI_WM00717 ENG_HU_Lugano Life_usa_enfusa_USA		Project:	
Dimension SPA: 2300x2300x600 mm Lin. El. max: 240 V-30A-60Hz Opt El. needs: 240V - 60A - 60Hz		Project No.: W000717	
Weight of the SPA: 387 kg max. capacity: 1000 kg Capacity: 6500 IN YVE 3 * IN L550 (6 KU)		Part No. P. 000	
Foil height: 110 mm		Approved by: Ross Tamis	
Created: 2024. 04. 15.		Driver: ross.tamis - 2024. 04. 15. 13:58:06	
1 person - 75 kg	Water disp.: 1600 liter	Number: WM00717	Page: 174
Minimum water:			

CONNECTION DIAGRAM

VIENNA LIFE

No.	Art. No.	US Name	Pos
1	AKU1892	Air Regulator - housed/lighted V2	5
2	AKU0056	Cup holder/light frame/light holder/transparent	6
3	AKU2447	Leaf housing with seal	6
4	AKU2319	Nut for leafhouse	16
5	AKU2471	Waterfall/lighted/stainless steel	1
6	AKU1893	On-Off tap house 33/transparent V2	1
7	AKU0291	Air dome with sealing V2	1
8	AKU0292	Cone nut seal-digging V2	1
9	AKU1891	Water Diverter - LED lighted V2	2
10	ARE0205	Reservoir/höz 2" x6cm (magas) lömléssel V2	3
11	A.00080	Self-capturing nut for suction head life	3
12	A.00282	Air water circulation seal/levelling medium gray for life	1
13	A.00083	Circulation jet nut seal-digging 48 life	1
14	AKU0084	Water Drain - 20 RB V2	1
15	ARE0201	Chem mixer - Housing	1
16	ARE0202	Mixer housing	1
Optional	17	ACM0874	Speaker 3" (2 way)
Optional	18	ACM0875	Grille for speaker 3" (2 way)
Optional	19	ACM0759	Control frame - INK500 GRECO
20	A.00076	Jail 3" - transparent Hole V3 Wells	22
21	A.00074	Jail 2" - transparent Hole transparent V3 Wells	40
22	AKU0136	Spoo Filter - 1.75 x 1.52 - Wells Antimicrobial Blue (line thread)	3
23	AKU1895	Air regulator grip Wells V2	5
24	AKU1894	Water Diverter - Grip Wells V2	2
25	AKU1896	On-off tap grip Wells V2	1
26	AKU1833	Filter house - Summer Cover gray with Wells logo	1
27	AKU0065	Flow 42/17 grey (RCD) light grey	4
28	AKU1835	Summer house light grey	1
29	ACM0854	Control box in YE-3	1
30	ACM0902	Circulation pump WTC/DM 250 W 60Hz	1
31	ACM0724	Spoo Pump 3 HP - One Speed 60 Hz	2

You must install a 30 mA residual-current device (RCD).



Sheet name: Vienna Life USA File name: EL_WHM0001_ENG_HU_Vienna_Life_madeinUSA	
Dimension SPA: 2300x2300x940 mm Weight of the SPA: 228 kg Rain height: 140 mm	Part No. 240 V-30A-60Hz / Opt El. needs: 240V-60A-60Hz Control box GECKO-YES-INK500-INKW Part No. GECKO-YES-INK500-INKW Number: WH00001
1 person ~75 kg Water disp.: 625 kg Minimum water: 7300 liter	Approved by: Reiss Tamas Designer: reiss.tamas@2024.04.16.7.5637 A3 M 1:20 page 17/4

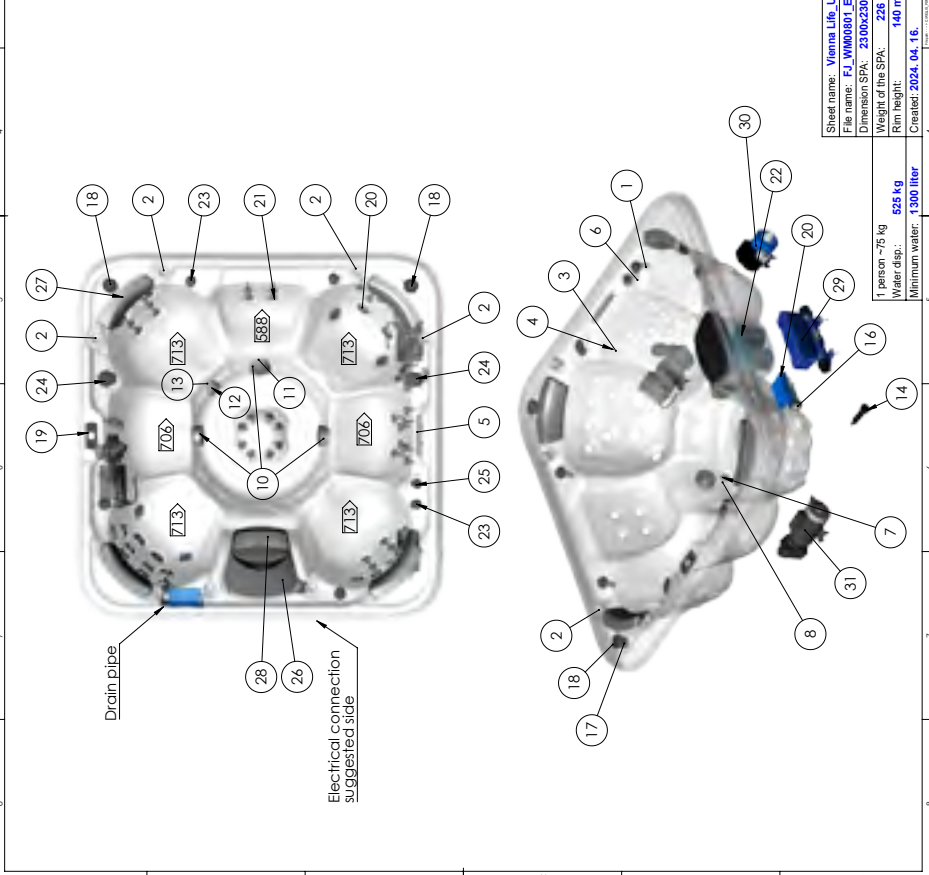

CONNECTION DIAGRAM

MALAGA LIFE

No.	Art. No.	IFS name	Pic.
1	AKU2647	Led housing with seal	1
16	AKU2219	Nut for red house	16
2	AKU2219	Nut for red house	16
3	AF0045	pillow holder	3
4	AKU1892	Air Regulator - house led lighted V2	F
5	AKU1893	On-Off tap house 33 transparent V2	2
6	AKU2625	Foundation lamina V3	3
7	AKU1916	Waterfall 22x6x31x48	1
8	AKU1891	Water Diverter 60 - LED lighted V2	1
9	AU0291	Jet ozone with sealing V2	1
10	AU0292	Ozone nut self-aligning V2	1
11	AU0246	Waister self-aligning	1
12	AKU1830	Filter house for footing 50 saf filters	1
13	AKU2607	RD Suction 2' with gasket	3
14	AU0285	RD Suction Nut	3
15	AU0286	RD Suction Compensation Ring	3
16	AU0282	Waister circulation self-aligning medium 85x40x116	3
17	AU0284	Circulation jet waister self-aligning 48 Lite	1
18	AU0283	Circulation jet nut self-aligning 48 Lite	1
19	AKU0754	Spa Pump 3 HP - One Speed 60 Hz	2
20	JCM0902	Circulation pump MTC20M 250 W 60Hz	2
21	ASE088	Pillow Holder - 17	4
22	ABE320	Ozen mixer - housing	1
23	ABE320	Mixer housing	1
24	AKU0854	Control box NY-E3	1
25	AKU0959	Control Panel - IN-K500 GECKO	1
26	AKU0874	Spander 3' (2 way)	2
27	AKU0902	LED control box (P woz)	1
28	AKU0902	LED control box	1
29	AKU0890	Mini-touch 2 Gecko USA 60Hz	1
30	AU0214	Jet 2' - transparent 1 Hole transparent V3 Wells	5
31	AU0214	Jet 3' - transparent 1 Hole V3 Wells	14
32	AU0217	Jet 3' - transparent 1 Hole (Red) transparent	8
33	AU0218	Jet 5' - transparent 1 Hole transparent V3 Wells	9
34	AU0219	Jet 5' - transparent 1 Hole (red) transparent	4
35	AKU1832	Filter House - Summer Cover round	1
36	AKU1894	Water Diverter - One Speed V2	1
37	AKU1892	On-Off tap house 33 transparent V2	2
38	AKU1891	Water Diverter 60 - LED lighted V2	1
39	AF0045	Pillow 300x126x45 with 60x60 bed	3
40	AKU1842	Summer house with Red Top	1

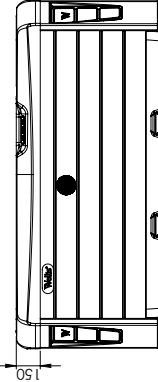

You must install a 30mA Residual-current device (RCD)

Sheet name: **Malaga Life USA**

File name: **EL_WIN0073_ENG_HU_USA_Malaga Life medence**

Dimension SPA: **2160x2160x900 mm | Jet 1: 240 V, 30A - 60Hz | Jet 2: 240 V, 30A - 60Hz | Jet 3: 240 V, 30A - 60Hz | Jet 4: 240 V, 30A - 60Hz**

Weight of the SPA: **353 kg** | **Redtop 220x65x145 - A-E09382** | **Control Panel GECKO-YE3 - IN-K500 - 4KVI**

Jet height: **150 mm** | Approved by: **Res Tamas** | File No. P. 0000

Created: **2024. 04. 12.** | Designer: **res.tamas - 2024. 04. 12. 15:02:29** | Issues: **A3** | Number: **WIN0073** | Page **1/4**

Product family: **WellaCityLife**

1 person - 75 kg

Water disp.: **290 l**

Minimum water: **7200 liter**

1 person - 75 kg

Water disp.: **290 l**

Minimum water: **7200 liter**

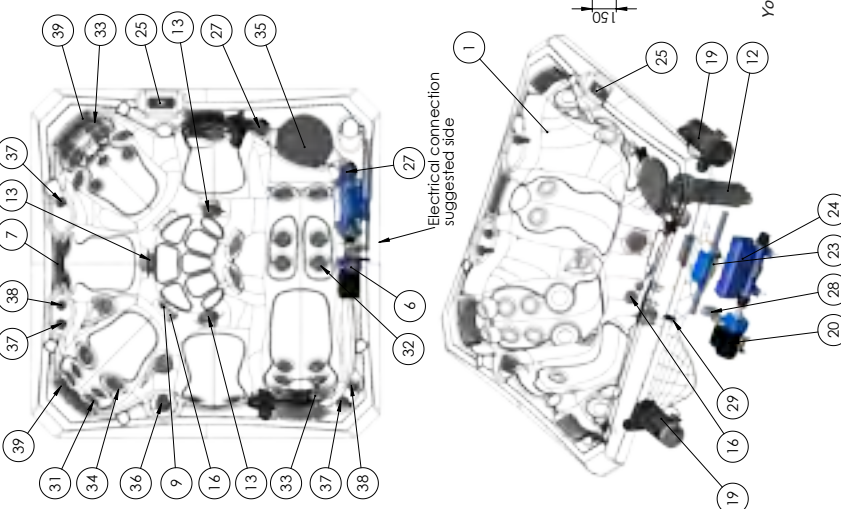

Electrical connection suggested side

CONNECTION DIAGRAM

LIMA LIFE

1	2	3	4	5	6	7	8
No.	Alt. No.	Part Name	Part No.	Part Name	Part No.	Part Name	Part No.
1	AKU1893	Control top house, 33 transparent V2					
2	AKU1892	Air Resistor - chrome bed/light V2					
3	AKU2101	Fountain lance V2					
4	AKU1916	Welder 631 27651x48					
5	AKU2447	Lead housing with seal					
6	AKU2219	Nut for bedhouse					
7	AJX0282	Jet water circulation self-heating medium gray for file					
8	AJX0284	Circulation jet water self-cleaning 48 L file					
9	AJX0283	Circulation jet nut self-cleaning 48 L file					
10	AKU1830	Filter house for floating 50 x41 fillers					
11	AJX0291	Jet cone with sealing V2					
12	AJX0292	Chrome nut self-cleaning V2					
13	AJX0246	Washer self-cleaning					
14	A850505	Beavertail nut Z* from (magaz) Tomiset V2					
15	AJX0281	Sealing for air adjusting suction head out life					
16	AJX0280	Self-cleaning nut for suction head life					
17	AJX0285	Sealing for air adjusting suction head out life					
18	ACM0734	50x P. mag. 3. 1P. 50x. Speed 60 Hz					
19	ACM0702	Circulation pump WCSOM 250 W 60Hz					
20	A850421	Clean tower - housing					
21	A850420	Water housing					
22	ACM0854	Control box in YE-3					
23	ACM0759	Control Panel - N. AS20 GECCO					
24	ACM0802	Left control box					
25	AJX0214	Jet 3" - transparent 1 Hole transparent V3 Wells					
26	AJX0216	Jet 3" - transparent 1 Hole Rotation transparent V3 Wells					
27	AJX0219	Jet 5" - transparent 1 Hole V3 Wells					
28	AJX0218	Jet 5" - transparent 1 Hole rotational transparent V3 Wells					
29	AJX0218	Jet 5" - transparent 1 Hole transparent V3 Wells					
30	AJX0301	Plow 30x3126x4 white ribbed					
31	AJX0305	31x41 flap grip Wells V2					
32	AKU1895	31x41 flap grip Wells V2					
33	AKU1842	Summer house with Wells top					
34	AKU1895	Air regulator opp Wells V2					
Optional	35	ACM0874	Spacer 5" (2-way)				
Optional	36	ACM0875	Grille for spacer 3" (2-way)				

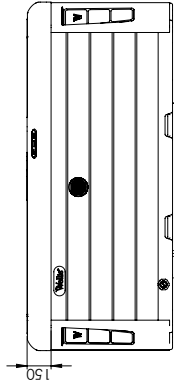

You must install a 30mA Residual-current device (RCD)

Sheet name: Lima Life USA

File name: EI_WW0074_ENG_HU_USA_Lima Life_melodyes

Dimension SPA: 2160x2160x60 mm | Ht. El. cte: 240 V, 30A - 60Hz | Opt El. reads: 240V - 60A - 60Hz

Weight of the SPA: 348 kg | Rating: 2300-cas5x-145 - AEO0382 | Control box: GECCO YE3 - WNC500 - 4KW

Item height: 150 mm | Approved by: **Reiss Talmes** | Part No. P. 0000 | Part No. P. 0000

Created: 2024. 04. 12. | Drawn: nass.talmes - 2024. 04. 12. 15:22:34 | Issues: A3 | M: 1:15 | page 174

Product family: **WellaCityLife**

Project no: **WellaCityLife**

1 person - 75 kg

Water disp.: 299 kg

Minimum water: 7300 liter

CONNECTION DIAGRAM

PRAGUE LIFE

No.	Art. No.	IF5 name	IF5 name
1	AU0247	Lead housing with seal	
2	AU0219	Nut for leadhouse	
3	A00045	allow holder	
4	AU01893	On-off tap house 33 transparent V2	
5	AU02437	Cap Holder Light - lens wells 2000	
6	AU02408	Cap Holder Light nut	
7	AU02497	Underwater light housing	
8	AU02392	Cap for underwater light (Wells)Chy	
9	AU01891	Water diverter 60 - LED lightcyl V2	
10	AU01892	Air regulator - houselid lighted V2	
11	AU01850	Filter house for housing 50 rad filters	
12	A000005	Berastoff hoz 2" from (magnet) 10mmsteel V2	
13	A-00081	Sealing for self-exhausting suction head nut life	
14	A-00080	Self-exhausting nut for suction head life	
15	A-00091	Jet ozone with sealing V2	
16	A-00082	Jet water circulation self-leveling medium gray for life	
17	A-00084	Circulation jet washer self-aligning 48 life	
18	A-00083	Circulation jet nut self-aligning 48 life	
19	AU00384	Water Drain - 20 RB V2	
20	A0E0021	Ozone mixer - Housing	
21	A0E0020	Mixer housing	
22	ACM0959	Control Panel - IN-0500 GECKO	
23	ACM0875	Gilles for speaker 3" (2 way)	
24	ACM0874	Speaker 3" (2 way)	
25	A-00014	Jet 2" - transparent Hole transparent V3 Wells	
26	A-00016	Jet 3" - transparent Hole V3 Wells	
27	A-00017	Jet 5" - transparent Hole Rotational transparent V3 Wells	
28	A-00019	Jet 5" - transparent Hole rotational transparent V3 Wells	
29	AU01832	Filter House - Stemmer Cover round	
30	AU01842	Stemmer house with Walktopp	
31	AU01864	On-off tap gpb Wells V2	
32	AU01895	Air regulator gpb Wells V2	
33	AU01894	Water Diverter - Grip Wells V2	
34	A-00088	Filter 300x28x03 white bonded	
35	A-00089	Filter 300x28x03 white bonded	
36	ACM0794	Loop Pump 3-Port - One Speed 60 Hz	
37	ACM0902	Circulation pump WCS04 250 W 60Hz	
38	ACM1054	Control box INTE3 GECKO (HxW) 60R x 13	

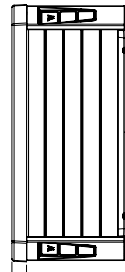

You must install a 30 mA residual-current device (RCD).

Product family: **WelliaCityLife**

Sheet name: **Prague Life USA spa**

File name: **EL_VM00003_ENG_Prague_Life_USA_residencio**

Dimension SPA: **2000x2000x850 mm** | Hx: **EL res: 240 V-30A-60Hz** | Opt EL res: **240V-40A-60Hz**

Weight of the SPA: **280 kg** | **Rating - A0E0001** | **Control box GECKO-YES-INK530-5KW**

Min height: **115 mm** | Approved by: **Res Tams**

Created: **2024. 04. 16.** | Drawn: **res.tamas - 2024. 04. 15. 15:52:45**

Number: **WH00003**

page **1/2**

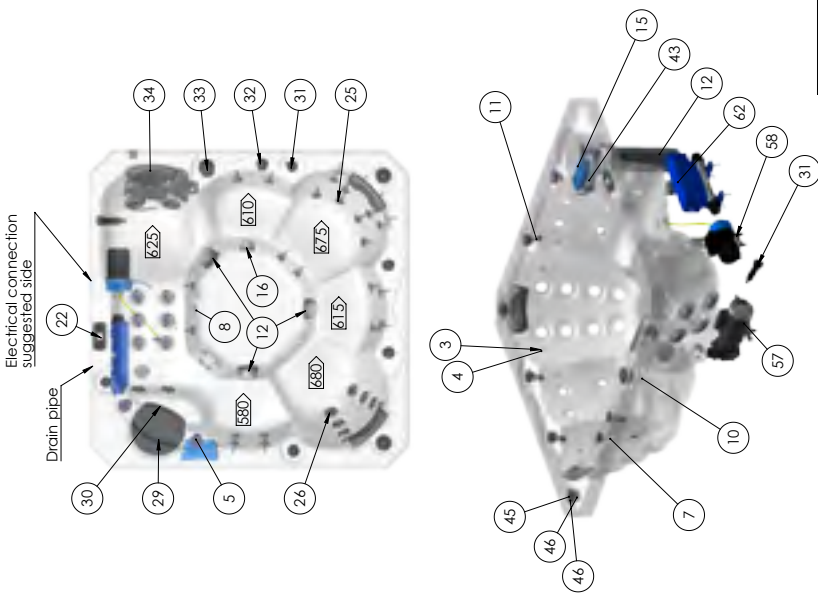

CONNECTION DIAGRAM

OSLO P&P

No.	Art No.	2	3	4	5	6	7	8	9
1	AKU2447	LED housing with seal							IF5 Ingress Protection EN
20	AKU2219	Nut for feedhouse							
3	AKU1892	Air Regulator - house led lighted V2							F
4	AK0045	filter holder							
5	AK0023	Jet house 2' with sealing V4 1/3							
6	AK0027	Nozzle housing nut self-clinging 2' VS 2/3							
7	AK0028	Washer for washer housing 2' VS 3/3							
8	AK0005	Bearing/die/hiz 2' from (megan) (omklasse) V2							
9	AK0081	Sealing for self adjusting suction head nut life							
10	AK0080	Self adjusting nut for suction head life							E
11	AK0091	Jet ozone with sealing V2							
12	AK0092	Ozone nut self-clinging V2							
13	AK0046	Washer self-clinging							
14	AK0037	Filter House - 60.3 S x 60.3 S - Slimmer							
15	AKU2607	RD Suction 2' with gasket							
16	AK0085	RD Suction Nut							
17	AK0086	RD Suction Compensation Ring							
18	AKM0921	ozone							D
19	AKM0945	Spoc Pump 1,5 HP - Two Speed 60Hz							
20	AKM0939	Control Panel IN K300 - One Pump							
21	AKM0929	Control Box IN 1/2 Circle 60Hz V3							
22	AKM0802	lead control box							
23	AKU0220	Jet 2' - transparent 1 Hole transparent V3 neutral							
24	AKU0222	Jet 3' - transparent 1 Hole transparent V3 neutral							
25	AKU0223	Jet 3' - transparent 1 Hole rotational transparent V3 neutral							
26	AK0042	Flow - 318 x 113 x 60 - Pol. V2 light grey							C
27	AKM0874	Speaker 3" (2 way)							
28	AKM0875	Grille for speaker 3" (2 way)							
29	AKU1895	Air regulator grip Wells V2							
30	AKM0926	Heating 14 kW GesteCo IN J control							
31	A8 B343								

Suggested electrical connection side

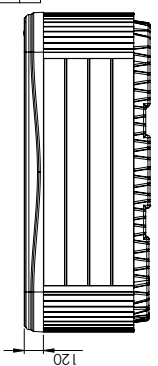
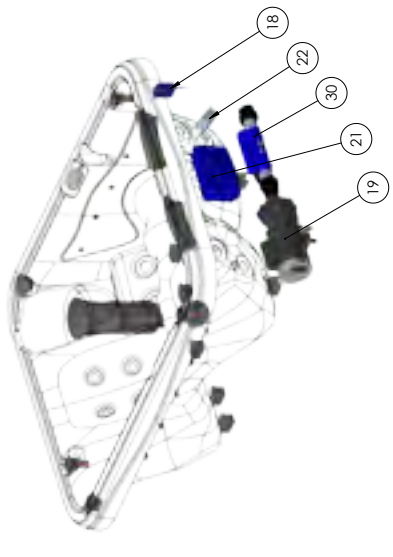
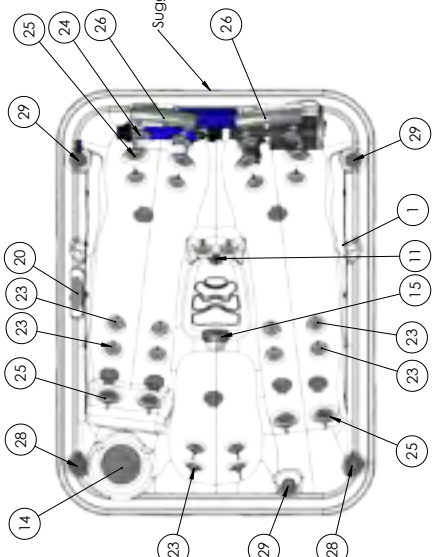

You must install a 30 mA residual-current device (RCD).

Product family: **WellaCityLife**

Sheet name: **Oslo P&P USA**

File name: **EL_Well00710_ENG_HU_Oslo_P&P_030_31_Indonesia_USA**

Dimension SPA: **2000x1500x760 mm | L x l x H | 120 V - 15A - 60Hz | Opt El. feeds: 120V - 15A - 60Hz**

Weight of the SPA: **170 kg | Rating: 1540x85x145 - A-EN0080 | Control box: GESCOK Y2A-C30-3KX (IM)**

Form height: **120 mm** | Approved by: **Res Tamas** | Part No.: **WellaCityLife** | Number: **Well00710**

Created: **2024. 04. 15.** | Drawn: **res.tamas - 2024. 04. 15. 13:47:31** | Issue: **A3 | M:1:5** | page 1/4

INITIAL INSTALLATION

Electrical preparations:

A clearly labeled emergency switch shall be provided as part of the installation. The switch shall be readily accessible to the occupants and shall be installed at least 5 feet (1.52 m) away, adjacent to, and within sight of, the unit.

Before installation the hot tub, the electrical system has to be prepared, as detailed in the below table.

Applicable cable: Copper 90°C (194°F) THHN/THWN	Ampere rating of the supply circuit overcurrent protective	AWG rating of the supply conductor
Lugano Life	50A	6
Vienna Life	50A	6
Malaga Life	50A	6
Lima Life	50A	6
Prague Life	40A	6
Manhattan Life	40A	6
Milano P&P	15A	6
Oslo P&P	15A	6

INITIAL INSTALLATION

SITE PREPARATION

When choosing a site for the hot tub take into account that its maintenance and repair works must be carried out on all four sides. Installing the tub into a deck, below a deck, or below level grade is not recommended.

1. INDOOR/BASEMENT INSTALLATION

If you place your hot tub indoors, be aware of some special requirements:

Water may accumulate around the hot tub, so the flooring material must have a proper runoff to avoid accumulation of water. When building a new room for the hot tub, constructing a floor drain is required, or damages may occur due to overflow, overfilling, or technical failure. Our company does not take responsibility for any damage in absence of floor drainage. Humidity will naturally increase in the room where the hot tub is located. For this reason ensure that the area has proper ventilation. We recommend installing a dehumidifier in the room.

2. OUTDOOR AND PATIO INSTALLATION

A solid horizontal foundation is necessary for installation of the hot tub. We advise using a reinforced concrete foundation at least 4" to 6" thick. Do not shim the spa, it may cause unreparable damages. The base needs to be even and horizontal. If the tub is not fully supported, it could cause structural damage and void the warranty.

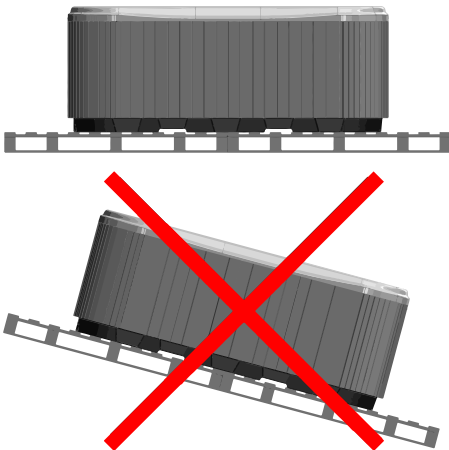

Ensure that your deck or foundation will support your hot tub. You must know the maximum load capacity of the foundation. Consult a qualified building contractor or structural engineer.

To find out the weight of your hot tub, its contents and occupants please refer to the hot tub specification chart. This weight must not exceed the structure's rated capacity per square foot, otherwise serious structural damages could result. If you install the hot tub outdoors, we recommend a reinforced horizontal concrete pad at least 4" to 6".

Install floor drains around your hot tub to lead water away even in heavy rain.

When constructing the water drain it is advised to form a 4" to 6" deep sloping ditch around the hot tub which directs water to the drain away from the hot tub. Water from the drain must be directed to the canal or a drainage with enough capacity.

Warning: Do not expose the hot tub to direct sunlight (not even empty) without proper coverage. The insulated hot tub cover preserves the water temperature and provides protection from sunlight and rain. When exposed to sunshine for an extended time it may damage the surface of the hot tub and the hot tub equipment.

Acrylic rapidly absorbs heat from sun rays, reaching a very high surface temperature which may damage the hot tub.

A hot tub placed in an indoor sunroom will need to block sun rays from reaching the hot tub directly through the glass as the ambient temperature may get too high.

3. IN-GROUND / SUNKEN HOT TUB

When sinking the hot tub into the ground you must make sufficient space for walking around the hot tub. For completion of maintenance works a minimum of 24" wide inspection pit must be built around the hot tub.

The inspection pit's bottom must be under the bearing point of the hot tub so that water can flow into the pit in case of water leakage. A floor drain or sump pump should be used at the bottom of the pit to ensure continual water drainage.

When sinking the hot tub only the portion below the hot tub's acrylic edge can be sunk. The air of the inspection pit may become stagnant. To prevent unpleasant odors proper ventilation must be provided (e.g. installing ventilators). The costs of pulling the hot tub out of the ground are borne by the user. If the aforementioned conditions are not present, setting up the hot tub may fail.

First filling of the hot tub

Proper filling of the hot tub is an important task both technically and chemically. We advise installation and periodic maintenance by the servicing professionals, which includes inspection and refilling of hot tub water. Hot tubs do not contain a water softener system and hard water damages the equipment. Improper filling of the hot tub may bring air into the system, which damages the heating element and motors. Repairs after such failures are not covered by warranty.

INITIAL INSTALLATION

Filling process

Remove the hot tub cover. First remove the trim pieces and corners. Then remove the side covers by unscrewing the bottom screws. During transportation the flare pump connection fittings of motors may have loosened. Check these connections before installation. If necessary, tighten the pump connection fittings.

Before filling the hot tub check that the Slice valves are not in a closed state (lever is pulled out and fixed with the safety lock).

Next fill the hot tub with water to the sign indicated on its sidewall.

Filling must be done through the filter housing. Improper filling can damage the motors and heating element.

Insert the filter or filter cartridges when proper water level is reached. Be cautious, because when replacing the filter cartridge air bubbles may remain in the cartridge. To avoid this the filter cartridges must be tilted in the water to remove air from them, and only then fitted to their place.



INITIAL INSTALLATION

IONIC EXCHANGE WATER SOFTENER AND CARBON FILTER (OPTIONAL)

For the optimal quality the following steps shall be followed during the usage:

1.

Please check the required water volume in the manual of the spa or contact our customer service for help. The exact volume is needed for the precise filling.

2.

Please remove the covering caps from both ends to connect the filling hose.



3.

Please connect the carbon filter to the water hose via the screw thread adapter (included with the filter).



4.

Please run water through the filter into a separate vessel until it becomes perfectly clear. This step allows the filter to rinse from the remaining carbon powder. The rinse cycle lasts for 30 seconds at most with approx 10 liters (2.5 gallons) of water.



0'-30'



>30'

5.

Through the clean filter fill up the spa with one third (1/3) of the total volume (e.g.: with 1000 liters (265 gallons) of total volume 1/3 is 300 liters (80 gallons)). It is important to follow the instructions of the filling for it is crucial to set the precise water hardness.



Insert the filter or filter cartridges when proper water level is reached. Be cautious, because when replacing the filter cartridge air bubbles may remain in the cartridge. To avoid this the filter cartridges must be tilted in the water to remove air from them, and only then fitted to their place.

6.

After the filling please remove the caps from the water softener cartridge and connect it with the carbon filter. With the water softener the rinsing is significantly faster, so only a 1 liter (1 quart) needs to be drained!



7.

Check the water hardness during the filling with the softener. There are many ways to test water hardness. Testers sold by Wellis display the hardness level on a color scale.

If the value shown is less than the optimal value the water will create foam during usage, if the value is more that will cause lime scaling.



8.

If the water hardness is extremely low during the filling please remove the softener cartridge and continue the filling with only the carbon filter as it shown at point 5.

MAINTENANCE

FILTER CARTRIDGE REMOVAL AND CLEANING

Cleaning mechanical contaminations via continuous water circulation and chemical mixture is a basic requirement for proper cleaning of the spa water. Every spa has a pump designed for this purpose. The circulation pump circulates the water through the filter(s). The filter protects against contamination floating in the water.

Cleaning of the filter cartridges is recommended weekly.

Soaking the filter cartridges in water mixed with chlorine or filter cleaning solution for 24 hours is recommended monthly.

Changing the filter cartridges is necessary every 3 months.

SURFACE MAINTENANCE

Wipe the surface with a wet cloth. Always use a neutral cleaning product and a soft wiping cloth. Never scratch the acrylic surface with an abrasive tool, blade, or knife, because it may cause damage. Never use nail polish remover, acetone, or paint stripper when cleaning the surface because it may cause damage.

Maintenance manual for the control panel of the spa:

- Do not damage the control panel with anything abrasive.
- Avoid exposing the control panel to direct sunlight.
- When not using the spa, always use a spa cover.

WINTERIZATION

Remember to correctly maintain the spa if you are not using it in the winter. If you are not using your spa during the winter months and want to put it out of service properly, call your authorized Wellis Retail Partner to schedule your spa to be winterized.

The winterization encompasses the following:

- Draining the spa
- Cleaning of the interior of the spa
- Draining the plumbing, jet lines, equipment pack, and pumps.
- The use of RV antifreeze to protect your tub from any water that may be left in the plumbing lines.
- Delivery - reception

If the spa is not winterized properly, the system can retain water that can easily freeze during the winter months. This can cause heavy damage to the pipes and the motors. This will void the warranty.

Maintenance of the out-of-service spa:

When you are not using the spa, use the thermo cover and fasten it with the buckles. Do not forget! If the spa is filled with water and you are not using it, lift the cover at least once a week to ensure proper ventilation. The thermo cover is multipurpose. Most importantly it decreases the heating time of the water to operational temperature and decreases the energy needed to maintain water temperature, decreasing the operational costs.

Using the cover you can avoid leaves, rain, snow, or other contamination entering the spa water, effectively sealing it off from environmental effects.

Fastening the cover with buckles prevents young children from using it without parental supervision.

CLEAN THE FILTER CARTRIDGES WEEKLY AS FOLLOWS:

WARNING!

Changing the filter cartridges is recommended every 3 months!

Operating the spa without a filter cartridge is PROHIBITED

1. Remove the lid of the filter.
2. Take out the filter cartridge.
3. Clean contamination from the cartridge with water.
4. Soak the cartridge in lukewarm water mixed with chlorine or filter cleaning solution. Follow the instructions on the filter cleaning solution bottle.

Never use an alkaline detergent or a high-pressure cleaner to clean the filter!



DRAINING THE WATER

You can drain the water via the drain outlet in accordance with environmental standards.

1. You'll need a hose and a wet and dry vacuum.
2. Pour the cleaner fluid into the water one day before draining and run the open jets at maximum performance for 20 to 25 minutes. The cleaner will remove any lime scale and dirt from the spa and its pipe work.
3. Before draining the spa remove the filters, this is a good time for cleaning or replacing them.
4. You don't need a pump for draining the water pull out the draining valve to the limit.
5. Remove the cap and attach the hose.
6. Push back the valve halfway then rotate and secure it in this position, this will start the flow of water. We recommend rinsing the tub while it drains.
7. When the tub is empty remove the hose and close the valve.
8. Use a wet and dry vacuum to clean up any remaining water from the spa and the jet nozzles.



JET DIRECTIONS

LUGANO LIFE



JET DIRECTIONS

VIENNA LIFE



JET DIRECTIONS

MALAGA LIFE



JET DIRECTIONS

LIMA LIFE



JET DIRECTIONS

PRAGUE LIFE



JET DIRECTIONS

MANHATTAN LIFE

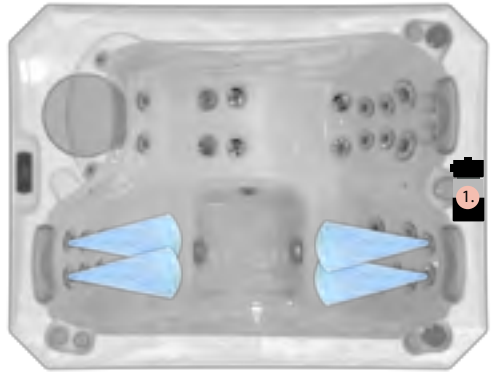
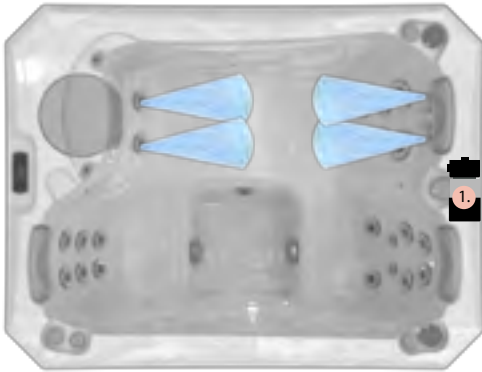
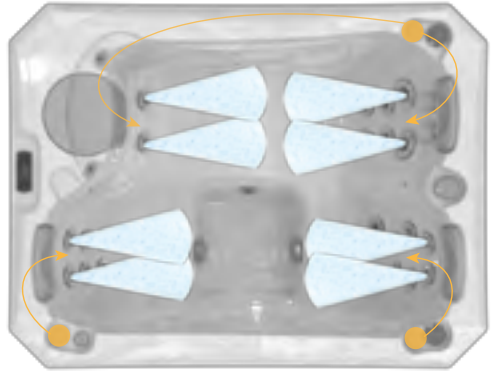
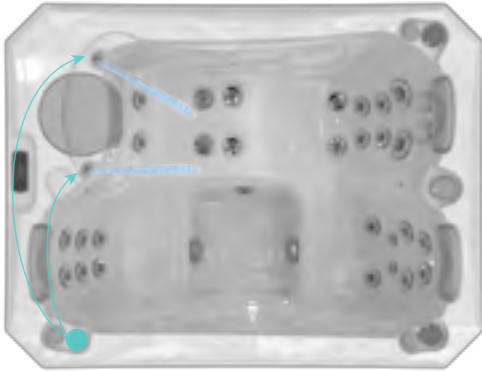

JET DIRECTIONS

MILANO P&P

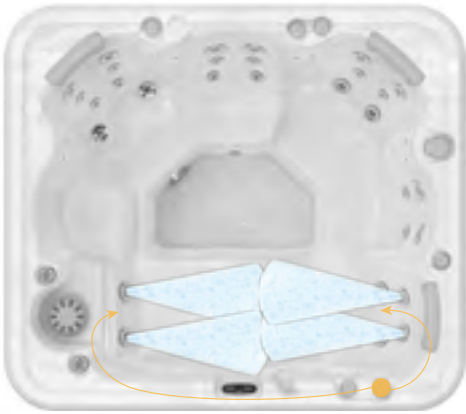

JET DIRECTIONS

OSLO P&P

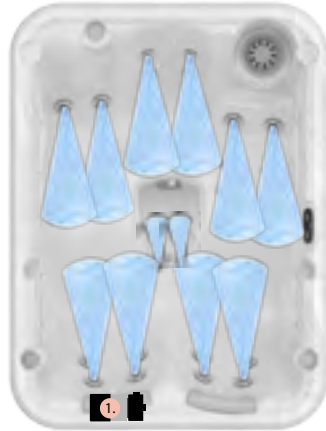
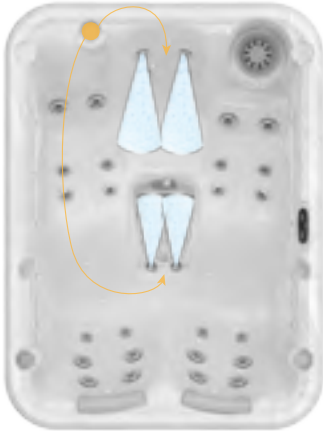
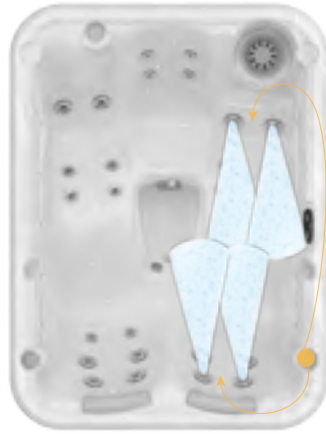
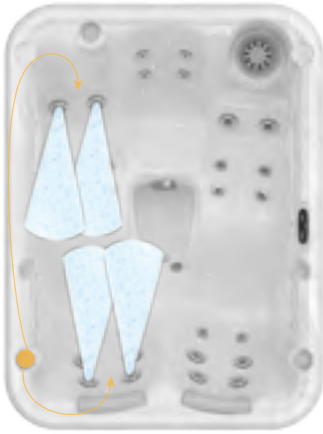

KEYPAD FUNCTIONS

in.k500 keypad layout

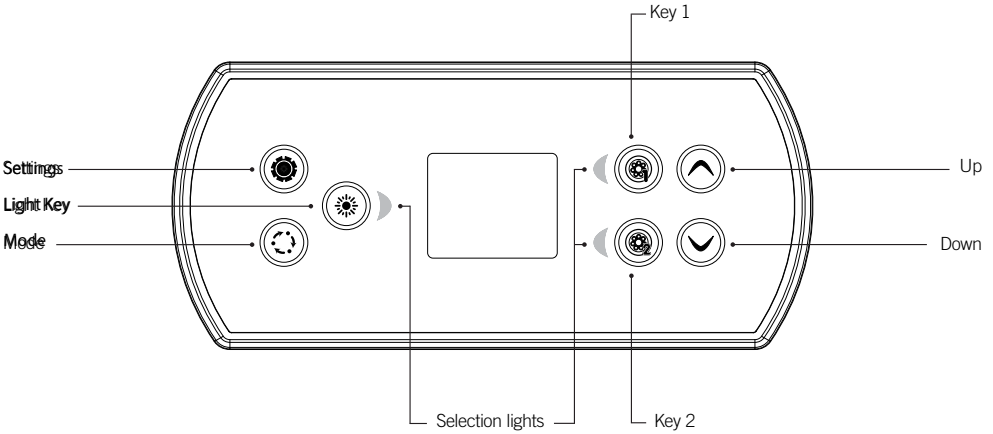

**Functions for keys 1 and 2 will depend on your system's low level configuration.*

Settings key

One press gives you access to a menu to manage the settings of your spa. Refer to the settings section for details about the settings menu.

Mode key

Successive presses on the Mode key will give access to control different optional accessories of your spa such as Audio and others. Note that if an accessory is not present in your spa configuration, its menu will not appear. Refer to the following section to get details about the possible accessories and their detailed functionalities. The screen will revert back to the spa mode if no key is pressed for 60 seconds.

If you don't have any accessories on your spa, the Mode key can be used to directly change your display orientation.



Power

Press any button to turn the keypad on. After 30 minutes without activity it will shut off.

Main screen

The main screen gives you access to your accessories and water temperature. At the bottom of the screen you will see any error or maintenance messages that are present.

KEYPAD FUNCTIONS



Start or stop accessories

To start or stop an accessory, press the associated button. Icons will become animated when their accessory is turned on, and inanimate when turned off. Icons on the screen will reflect the speed or state of the devices running on your spa.

When an accessory has more than two states, press the button until it reaches the desired state.

Note (version 14.00 and higher):

A special buttons and icons mapping may be used when the spa configuration has 4 accessories* (3 pumps and a blower or 4 pumps and no blower). In this case only, buttons and icons are divided in 2 sets of accessories.

Button #1 starts or stops pump #1 and pump #2.

Button #2 starts or stops Pump #3 and Pump #4/blower.

Corresponding icons will be animated when one or more accessories are on.

** Only Pump #1 can have a dual speed.*



Water temperature

The temperature shown at the top of the screen is the current water temperature. Use the Up and Down buttons to set the desired temperature.

The set point will appear in blue at the bottom. After 3 seconds without any change to the set temperature value, the keypad will resume the normal display of messages.

When the set value is lower than the current temperature Cooling to xx.x will appear. When the set value is higher than the current temperature, Heating to xx.x will be indicated. Normally there is a short delay before the heating starts, during which Heating Suspended is indicated.

KEYPAD FUNCTIONS



Settings

From the home page you can access the Settings, where you will find:

- *Water care*
- *Heat Pump (if installed)*
- *Audio (if installed)*
- *in.clear-200 (linked version)*
- *Standby*
- *Maintenance*
- *Date & time*
- *Keypad*
- *Wi-Fi*
- *Config*
- *Restore*
- *About*

Use the arrow keys to move up and down in the list.

To select an option, press the lit button beside it (Light button).

At any point you can press the Settings button to return to the home screen.

KEYPAD FUNCTIONS



Water care

The Water Care section will help you set up your ideal filtration and heating settings. Choose from Away, Standard, Energy Savings, Super Energy Savings, and Weekender, depending on your need. Use Light key to choose your setting. A checkmark will appear on the selected icon to confirm.

In Economy mode, the set point will be reduced by 20°F*, which means that the heating system will not be engaged unless the temperature falls to 20°F below the spa's set temperature.

**Default pack value*

Water care modes

Away:



In this mode the spa will always be in economy; the set point will be reduced by 20° F*.

Standard:



The spa will never be in economy mode and will be filtering according to the pack's low level configuration.

Energy Savings:



The spa will be in economy mode during the peak hours of the day and resume normal mode on the weekend*.

Super Energy Savings:



The spa will always be in economy mode during peak hours, every day of the week*.

Weekender:



The spa will be in economy mode from Monday to Friday, and will run normally on the weekend*.

**Filtration will be reduced when the economy mode is active.*

KEYPAD FUNCTIONS



Modifying schedules

To see and/or modify a Water Care category, use the lit button to the right (Key 1) to open the selected Water Care menu.

Use the arrow keys to choose a schedule to modify (choice of economy and filtration schedules). Use the Light key to move between parameters.

You have several possibilities for the schedule (Mon-Fri, weekend, every day, or single days). The schedules will be repeated every week. The time and duration are set in 30 minute increments. Once you have set the schedule, use Key 1 to go back. Ensure that you have selected the desired Water Care option in the main Water Care menu.



The filtration schedule shown on the screen will apply to the main filtration pump, most likely pump 1. If your spa uses a circulation pump configured to run 24 hours, the screen will show you the purge setting instead of filtration. The purges are pre-programmed for a fixed number of minutes, therefore the duration will be set to N/A on the screen, and only the start time can be modified.

KEYPAD FUNCTIONS



Heat pump

This menu allows you to change the regulation mode of your heat pump. You can choose from Eco Heat, Smart Heat, Eco Auto, Smart Auto, Cool and Electric.

A green checkmark indicates the currently selected regulation mode. To change the setting, simply navigate the menu using the arrow key and press the Light Key to choose the desired regulation mode.

Heat pump modes

Eco Heat



In this mode, the heat pump is used as the unique source of heating. The heating element is kept off and the heat pump is not used to cool the water should its temperature rise above the current set point.

Smart Auto



This mode borrows functionality from both Smart Heat and Cool modes and has the ability to select the proper Heat or Cool mode automatically according to the water temperature. The heating element is activated only if there is a large temperature difference between the water and the set point.

Smart Heat



This mode uses the heat pump as the main heating source. The heating element is turned on only if there is a large temperature difference between the water and the set point. The heat pump is not used to cool the water in this mode.

Cool



This mode uses the heat pump in cooling mode only. The heat pump is not used as a heating source and the heating element is never activated.

Eco Auto



This mode borrows functionality from both Eco Heat and Cool modes and has the ability to select the proper Heat or Cool mode automatically according to the water temperature. The heating element is never activated in this mode.

Electric



This mode keeps the heat pump off and uses only the heating element to regulate water temperature.

KEYPAD FUNCTIONS



Maintenance

From the Settings page you can access the Maintenance menu, which gives you access to the following options:

- *Maintenance reminders*
- *Standby*

Use the Up and Down keys to make a selection, and Light key to confirm.



Maintenance reminders

The in.k500 keypad will remind you of maintenance required on your spa, like rinsing or cleaning the filter. Each task has its own duration, based on normal use.

The Maintenance reminders menu allows you to verify the time left before maintenance is required, as well as to reset the time once a task is completed.

Use the Up and Down keys to move through the list.

To reset a task select it by pressing Light key, then confirm when prompted . Once you have confirmed the task will be reset.



Standby

The Standby mode allows you to service your spa . Pumps will stop for 30 minutes, and automatically restart after this time.

Once Standby mode has been activated a screen will appear to show that pumps are stopped. The normal spa page will return at the end of maintenance.

Press the Key 1 to leave Standby mode and restart the spa.

Note:

In version 6.00 only, Standby mode is accessible directly from the Settings page.

KEYPAD FUNCTIONS



Date and time

Here you can adjust the time format, change the year, date and time. Use the arrows to choose the setting that you want to adjust, and select it by pressing the Light key.

Use the arrow buttons to change the parameters, and the Light key to move between parameters. Key 1 will take you back to the main Settings menu.

Note:

In version 6.00 and earlier, only the day of the week can be changed, and not the year or date.



Keypad settings

In this section, you can change the temperature unit, language, display orientation, rim light color and keypad security. Note the spa pack must be configured accordingly to be able to change the rim light color.

When you change the display orientation, the contextual options and arrow keys adjust to the chosen orientation. If you don't have any accessories installed on your spa, the Mode key can be used as a display orientation key. Simply press on it to change your orientation from normal to inverted, and vice versa.

Whether the display is inverted or not, the Mode and Menu keys remain unchanged, as well as the accessory keys in the main Spa menu.

With the in.k500 equipped with a selectable rim light color modul: If the "RGB backlight" option is enabled in the spa configuration an option will appear to allow selection of the keypad rim light color.

You can lock the keypad by selecting one of 3 security levels: Unlock, Partial or Full. The Partial level locks the set point adjustment and many options in the settings menu. The Full level locks all keypad functions. To unlock the keypad (either Partial or Full), press and hold the Light key for 5 seconds.



KEYPAD FUNCTIONS



WiFi (in.touch only)

For the WiFi menu to appear in the Settings menu your in.touch module must be equipped with software version 11.00 or higher. This menu allows you to connect your in.touch module to a WiFi network or to change its network.

For more details about other in.touch connection methods please see the in.touch techbook.

To connect your in.touch module to a wireless network, use the Up/Down keys to go to the WiFi option in the Settings menu and Light key to select it.

After a few seconds the available networks will appear on the screen, as well as their signal strength.

Use the Up/Down keys to move through the list. Select your network by pressing on Light key.

If the WiFi network is password protected enter it when prompted.

- Use the arrow keys to choose your letters and change the type of character (uppercase, lowercase, number, symbol).
- Use Key 2 to move the cursor forward
- Use Key 1 to backspace
- Use Light key to confirm

If no password is required the in.touch will connect automatically.



Once the in.touch module is connected to a WiFi network a check mark in a green circle will appear in the WiFi menu, and the network logo will change to green in Settings menu.

Note:

WiFi logo color in Settings menu corresponds to the in.touch connection state.

Yellow = not connected

Green = connected to a network

Yellow with wait icon = connection attempt to a network

Red with wait icon = in.touch no longer detected

(in.touch must be reset before next connection attempt)

KEYPAD FUNCTIONS



Config

Please do not make changes in the electrical configuration section unless you are a qualified electrician.

In this section you can change the low-level configuration, number of phases, input current and heat pump current.

Use Up/Down to move between parameters, and the Light key to select a parameter to change. Please refer to the techBook of your specific control system for spa for details about the low level settings.

Once you have changed the Number of Phases in the menu, you will be unable to use the Up/Down keys to return to the Low-level Configuration menu. Please go back and re-enter the Config menu.

Note with version 15.00 and higher:

Depending on the pack configuration, a code may be required to change these settings. This code is "5555".

KEYPAD FUNCTIONS

The list below shows the different error messages that can appear on the home screen.
Refer to the troubleshooting and error codes section of the TechBook for your spa pack system.

Code	Message
HL	Warning! HL Error
FLO - L01	FLO - L02 FLO FLO condition - Check filter, pump, blockage, air lock and water level
NO FLO	Persistent NO FLO, all off - Check filter, pump, blockage, air lock and water level
HR	Danger! Relay stuck
OH	Warning! Spa temp. high
Pr	Warning! Temp. probes defective
AOH	Internal pack temp. high
FLC	Flow switch closed
SP in	Input voltage issue
F1	in.xm2 Fuse # 1 is blown
F2	in.xm2 Fuse # 2 is blown
F3	in.xm2 Fuse # 3 is blown
Hr	Danger! Thermal fuse error
UPL	The spa pack does not have valid software. Please insert valid in.stick to reprogram spa pack.

USER INTERFACE - IN.K300

EASY 4

COMPACT FULL-FUNCTION KEYPAD

The Quick Reference Card provides an overview of your spa's main functions and the operations accessible from your digital keypad. This QRC depicts a generic overlay, custom versions may vary.

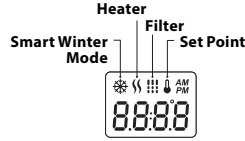

1 PUMP MODEL

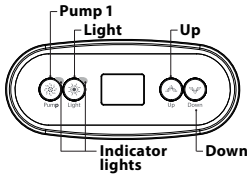

2 PUMP MODEL

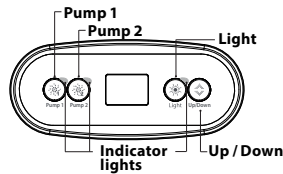

SPA FUNCTIONS

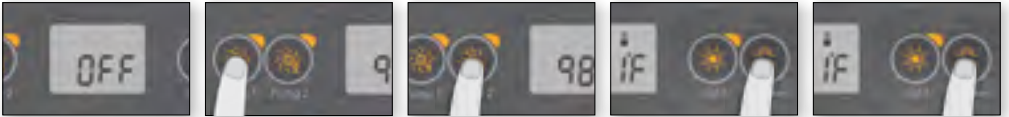

OFF MODE

Pressing Pump 1 for 5 seconds will enable the Off mode. This mode allows you to stop all outputs including automatic functions such as filter cycle, heat request and smart winter mode for 30 minutes to perform quick spa maintenance. When Off mode is active, the display will toggle between the "OFF" message, the clock and the water temperature.

The spa light will flash for a few seconds before the end of the 30 minutes to warn you that the system is about to resume its normal operation. Press Pump 1 or Pump 2 (if available) to restart the system before the expiration of the 30 minute delay. When the system resumes its normal operation, the display shows "On" for 3 seconds.

PUMP 1

Press Pump 1 key to turn Pump 1 on at low speed. Press a second time to turn pump to high speed (with a dual-speed pump*). A third time turns pump off. A built-in timer automatically turns pump off after 20 minutes, unless pump has been manually deactivated first.

The "Pump 1" indicator lights up when Pump 1 is on. With a dual-speed pump, the indicator will flash when pump 1 is on at low speed.



PUMP 2 KEY

Not available on all models
Press Pump 2 key to turn Pump 2 on at low speed. Press a second time to turn pump to high speed (with a dual-speed pump*). A third time turns pump off. A built-in timer automatically turns pump off after 20 minutes, unless pump has been manually deactivated first.

The "Pump 2" indicator lights up when Pump 2 is on. With a dual-speed pump, the indicator will flash when pump 2 is on at low speed.



LIGHT KEY

Press Light key to turn light on. A second press turns light off. A built-in timer automatically turns light off after 2 hours, unless it has been manually deactivated first.

The "Light" indicator lights up when light is on.



UP/DOWN KEYS

Use Up or Down key to set desired water temperature. The temperature setting will be displayed for 2 seconds to confirm your new selection.

2 pump spas have a combined Up/Down key. Hold the button to increase the parameter and release the button to stop. Hold the button again to decrease the parameter.

The "Set Point" icon indicates that the display shows the desired temperature, NOT the current water temperature!



*If single speed pump: press Pump key to turn pump on. Press Pump key again to turn pump off.

USER INTERFACE - IN.K300

PROGRAMMING STEPS

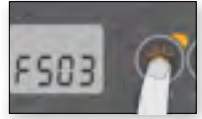
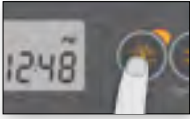

PROGRAM MENU



The program menu is accessible by holding down the Light key for 5 seconds. In the program menu the following parameters can be set: clock, the filter or purge cycles, economy mode and temperature units. While you are in the program menu, use the Up or Down key to adjust the parameters and use the Light key to jump to the next parameter.

The changes will be saved after the confirmation of the last parameter only. If there is no action taken for 10 seconds, the system will exit the program menu without saving any changes.

SETTING THE CLOCK

Enter the program menu by holding down the Light key for 5 seconds. The display will show the current clock setting with the hour flashing.

Depending on factory settings your system may be set to 24-hour time or 12-hour time.

Setting the hour: Use the Up or Down keys to adjust the hours. Press the Light key to jump to the next parameter, the minutes.

Setting the minutes: Use the Up or Down keys to adjust the minutes. Press the Light key to jump to the next parameter, the filter or purge start time (FS).

PROGRAMMING THE FILTER/PURGE CYCLES

Depending on system configuration your spa will perform either a filter or a purge cycle. The filter cycle menu consists of the following parameters: the start time (FS), the duration (Fd) and the frequency (FF). The purge cycle menu consists of the following parameters: the start time (FS) and the frequency (FF).

A filter cycle consists of starting all the pumps and blower in high speed for 1 minute (purge step) then, the pump associated with the filter will run in low speed for the remaining duration of the filter cycle (clean step).

A purge cycle is used when the spa is equipped with a 24 hour circulation pump which provides a continuous clean step. It consists of starting all the pumps and blower in high speed for 1 minute.

SETTING FILTER OR PURGE CYCLE START TIME

The display will show FSxx, "xx" representing the starting hour of the cycle. Use the Up or Down key to adjust the hours. Use the Light key to jump to the next parameter, filter duration (Fd).

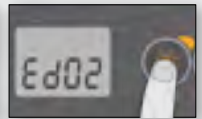
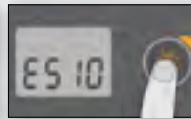
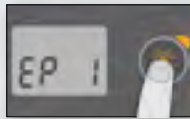
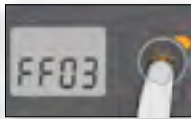
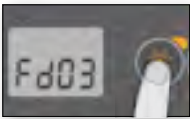

SETTING FILTER CYCLE DURATION

(not available on purge systems)

The display will show Fdxx, "xx" representing the duration in hours of the filter cycle. Use the Up or Down key to adjust the duration. Use the Light key to jump to the next parameter, filter or purge frequency (FF).

0 = no filtration

24 = continuous filtration

It is not recommended to set this to "0".

SETTING FILTER OR PURGE CYCLE FREQUENCY

The display will show FFxx, "xx" representing the number of cycles per day. Use the Up or Down key to adjust the frequency. Use the Light key to jump to the next parameter, economy mode (EP).

The "Filter cycle" indicator lights up when filter is on and flashes when suspended.

SETTING ECONOMY MODE

This mode allows you to lower the temperature set point of the spa by 20 °F (11 °C) during a certain period of the day.

The display will show EPx, "x" representing the state of the programmed economy (0 = disabled, 1 = enabled). Use the arrow keys to enable or disable economy mode. Use the Light key to jump to the next parameter, economy start time (ES).

SETTING ECONOMY START TIME

The display will show ESxx, "xx" representing the hour at which the economy mode will become active. Use the Up or Down key to adjust the hour. Use the Light key to jump to the next parameter, economy duration (Ed).

When the Economy mode is ON, the display will toggle between the "Eco" message, the time, and the water temperature.

SETTING ECONOMY DURATION

The display will show Edxx, "xx" representing the duration in hour of the economy mode. Use the Up or Down key to adjust the hour. Use the Light key to jump to the next parameter, temperature unit.

24 = continuous economy

Note that the parameters for the economy mode settings are associated to specific low level configuration of the system that are not present in all software revisions.

USER INTERFACE - IN.K300



SETTING TEMPERATURE UNIT

Water temperature can be displayed in either Fahrenheit (°F) or Celsius (°C). The display will show F or C.

Use the Up or Down key to change the setting. Use the Light key to save all the parameters.

SMART WINTER MODE

Our Smart Winter Mode protects your system from the cold by turning pumps on several times a day to prevent water from freezing in pipes.

The "SWM" indicator lights up when freezing is detected and flashes when the purge is active.

COOLDOWN

After heating the spa water to the desired Set Point, the heater is turned off, but its associated pump (Pump 1 low-speed or CP) remains on for a predetermined period of time to ensure adequate cooling of the heating element, prolonging its useful life.

WATER TEMPERATURE REGULATION

Every 15 to 90 minutes the pump will run to ensure accurate water temperature readings as well as avoid heater activation in dry conditions. After verifying pump activation and taking a water temperature reading if required, the system

automatically turns the heater on to reach and maintain water temperature at Set Point.

 Indicator flashes when taking water temperature reading.

TROUBLESHOOTING SECTION

Should an error occur, the display will show one of the following error messages toggled with the clock and the water temperature.

IN.XE ERROR CODES

DESCRIPTION



Hr

An internal hardware error has been detected in the in.xe.
Contact dealer or service supplier.



HL

The system has shut the heater down because the temperature at the heater has reached 119°F (48°C).

Do not enter the water! Remove the spa cover and allow the water to cool down, then shut power off and power your spa up again to reset the system.



AOH

Temperature inside the spa skirt is too high, causing the internal temperature in the in.xe to increase above normal limits. Open skirt and wait until error clears.



FLO

The system does not detect any water flow while the primary pump is running.

Check and open water valves. Check for water level.
Clean filter. If the problem persists, call your dealer or service supplier.



Prr

A problem is detected with the temperature probe.

Call your dealer or service supplier.



OH

The water temperature in the spa has reached 108°F (42°C).

Do not enter the water! Remove the spa cover and allow the water to cool down to a lower temperature.

Call your dealer or service supplier if problem persists.

OTHER ACCESSORIES - THE HEAT PUMP (OPTIONAL)

For further information see the original user manual of the heatpump. It shows the installation and technical details.

CONTROL PANEL

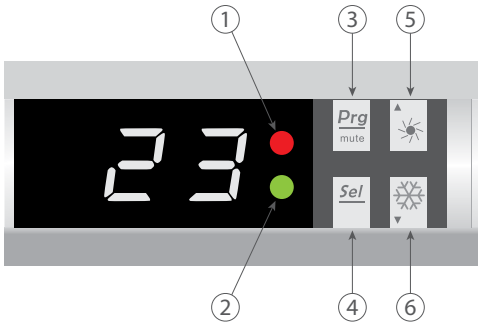

1. Heating mode indicator
2. Cooling/Defrost mode indicator
3. ON/OFF button
4. Mode button
5. Plus (+) button
6. Minus (-) button

OPERATING MODE SELECTOR



BEFORE STARTING, ENSURE THAT THE FILTRATION PUMP IS WORKING AND THAT WATER IS CIRCULATING THROUGH THE HEAT PUMP.

Prior to setting your required temperature, you must first select an operating mode for your remote control:



HEATING MODE

Select the heating mode for the heat pump to heat the water in your spa.





COOLING MODE

Select the cooling mode for the heat pump to cool the water in your spa.

OTHER ACCESSORIES - THE HEAT PUMP (OPTIONAL)

HEATING MODE

Step 1: Press  to switch on your pump.

Step 2: Press  to switch from one mode to another until the heating mode is displayed.

Step 3: Using buttons  and  select the required temperature.

EXAMPLE:

If the current temperature is 15°C, default setting temperature is 27° required temperature is 30°C.

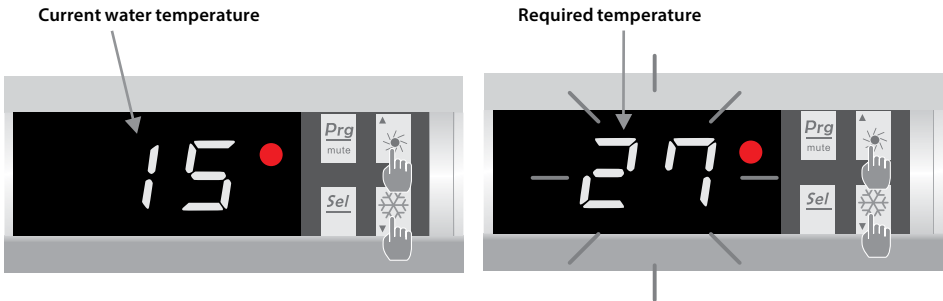

USEFUL INFORMATION ABOUT HOW THE HEATING MODE OPERATES

When the incoming water temperature is less than or equal to the required temperature (setpoint temperature) -X°C, the heat pump will switch to heating mode. The compressor will stop when the temperature of the incoming water is greater than or equal to the required temperature (setpoint temperature).

Indicators for adjustment range X and Y

X: adjustable parameter from 1° to 10°C, default setting is 3°C. (Parameter "H")

OTHER ACCESSORIES - THE HEAT PUMP (OPTIONAL)

COOLING MODE

Step 1: Press  to switch on your pump.

Step 2: Press  to switch from one mode to another until the cooling mode is displayed.

Step 3: Using buttons  and  select the required temperature.

EXAMPLE:

If the current temperature is 30°C, default setting temperature is 27° required temperature is 15°C.

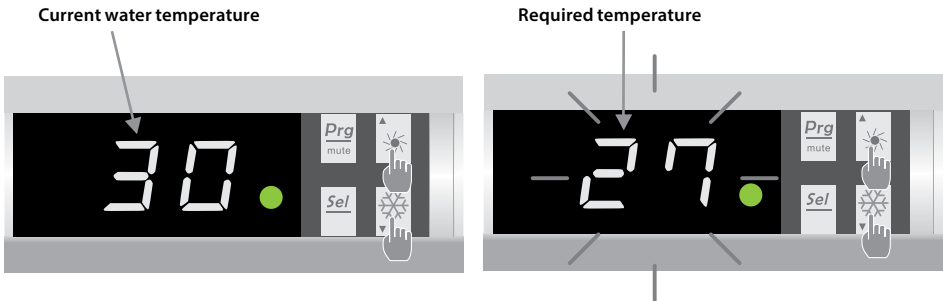

USEFUL INFORMATION ABOUT HOW THE COOLING MODE OPERATES

When the incoming water temperature is greater than or equal to the required temperature (setpoint temperature) + X°C, the compressor will switch to cooling mode. The compressor will stop when the temperature of the incoming water is less than or equal to the required temperature (setpoint temperature).

Indicators for adjustment range X

X: adjustable parameter from 1° to 10°C, default setting is 3°C. (Parameter "H")

OTHER ACCESSORIES - THE HEAT PUMP (OPTIONAL)

STATUS VALUES AND ADVANCED SETTINGS



WARNING: This operation is used to assist servicing and future repairs.
The default settings should only be modified by an experienced professional person.

THE SYSTEM'S SETTINGS CAN BE CHECKED AND ADJUSTED VIA THE REMOTE CONTROL BY FOLLOWING THESE

Step 1: Keep pressing  until you enter the settings verification mode.

Step 2: Press  and  for see the parameters.

Step 3: Press  to select the setting to be modified.

Note, some settings cannot be modified. Consult the settings table for further information.

Step 4: Press  and  to adjust the setting value.

Step 5: Press  to set the new value.

Step 6: Press  to return to the main screen.



PARAMETERS TABLE

N°	Description	Range value	Default value	Comment
A	Water temperature	-19~99°C		Actual data
b	Evaporator temperature	-19~99°C		Actual data
c	Ambient air temperature	-19~99°C		Actual data
d	Setting temperature in heating mode	15~40°C	27°C	Adjustable
E	Defrosting mode activation timer	10~80 min	40 min	Adjustable
F	Defrosting mode maximum duration	5~30 min	8 min	Adjustable
G	Setting temperature in cooling mode	8~28°C	12°C	Adjustable
H	Adjustment of temperature difference for restart	1~10°C	3°C	Adjustable
J	Automatic restart	0=OFF, 1=ON	1	Adjustable
O	Antifreeze protection – low air temperature	-10~15°C	-5°C	Adjustable
P	Evaporator temperature to enter defrosting mode	-19~0°C	-3°C	Adjustable
U	Evaporator temperature to exit defrosting mode	1~30°C	20°C	Adjustable
t	Reserved - Do not modify			Reserved
L	In.grid	0=OFF, 1=ON	1	Adjustable

For further information see the original user manual of the heatpump. It shows the installation and technical details.

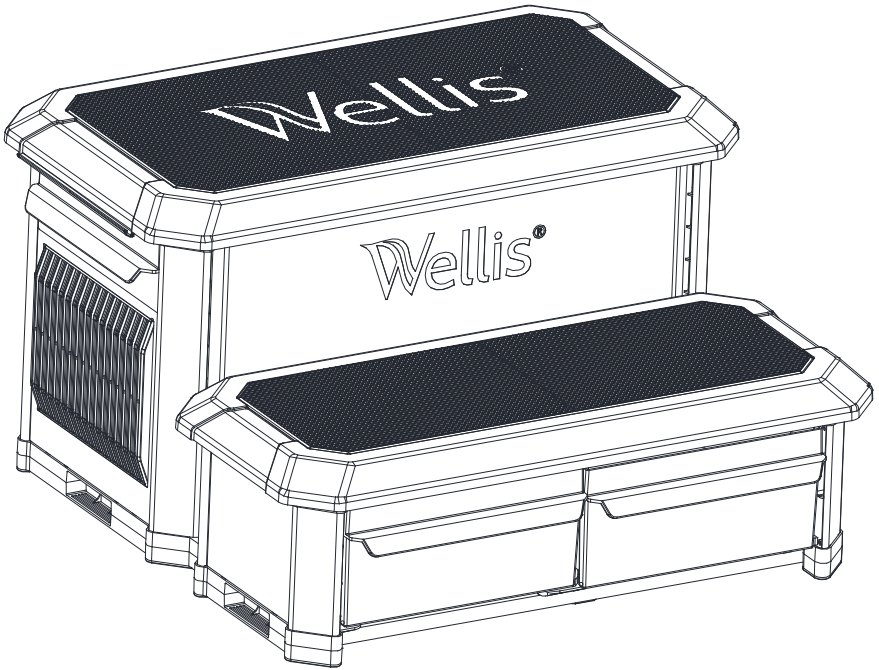

SMART STEP MANUAL (OPTIONAL)

SAFE USE



To reduce the risk of drowning, falls, paralysis, electrocution, or other serious injury or death:

Use step properly.
Use for intended purpose only.

- **No diving or jumping from steps** - shallow water, risk of paralysis or death.
- **ONE PERSON ON THE LADDER/STAIR AT A TIME.**
- **Illuminate the steps** when using the spa at night.

Weight limit - 300 lbs maximum. Exceeding maximum weight may cause the step to fail.

Secure the spa when not in use. - (for example, with a locked cover or secure gate) - refer to local codes.

Watch children at all times when they are in or around water to help prevent drowning.

BE SURE AND SAFE. - The manufacturer **IS NOT** responsible for improper assembly, installation and use.

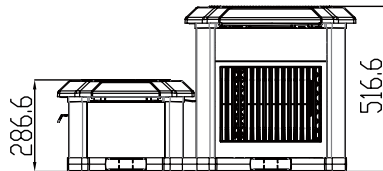
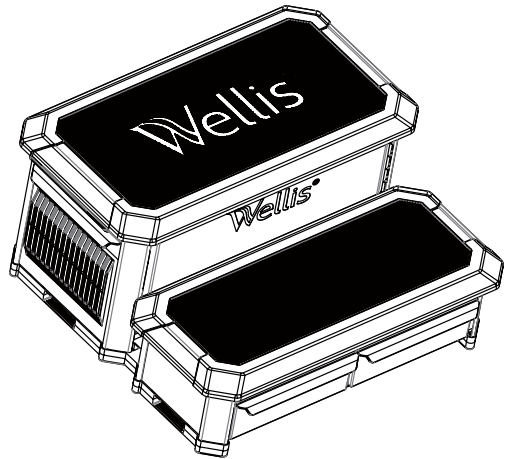
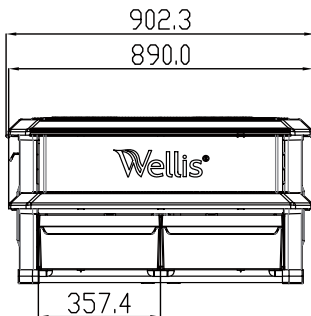
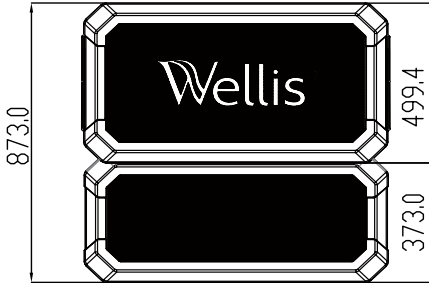

SMART STEP MANUAL (OPTIONAL)

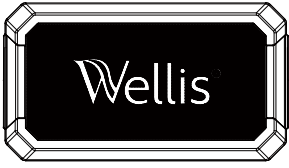

WE0135-1

1x

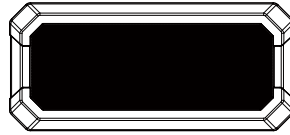

WE0135-2

1x

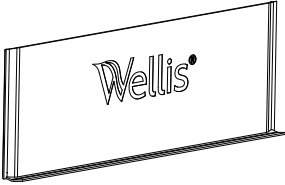

WE0135-5

1x

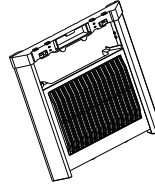

WE0135-6

1x

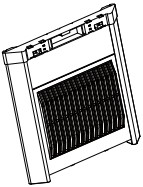

WE0135-7

1x

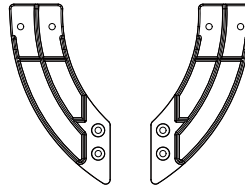

WE0135-10&11

1x

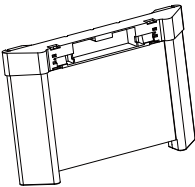

WE0135-13

2x

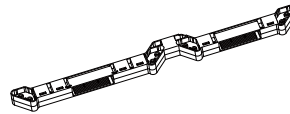

WE0135-14

2x

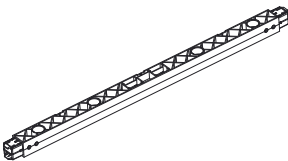

WE0135-15

11x

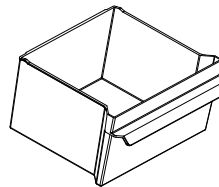

WE0135-16

2x

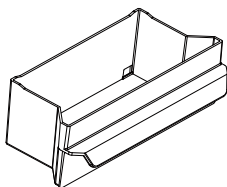

WE0135-17

1x

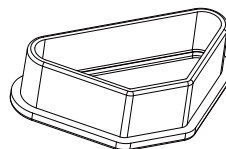

WE0135-18

8x

SMART STEP MANUAL (OPTIONAL)

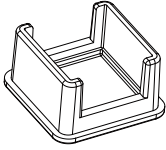

WE0135-19

5x

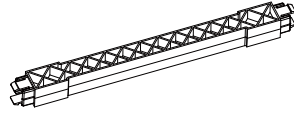

WE0135-20

2x

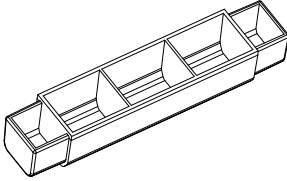

WE0135-21

2x

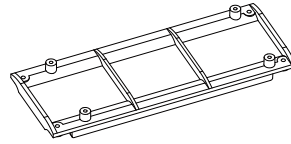

WE0135-22

2x

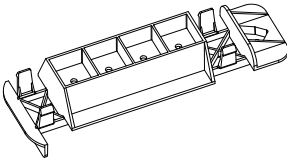

WE0135-23

2x

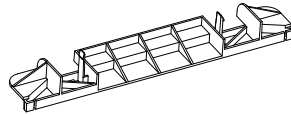

WE0135-24

2x

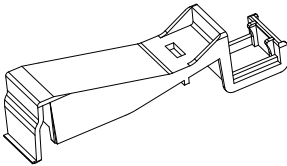

WE0135-25

6x

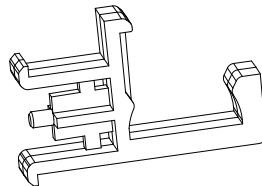

WE0135-26

8x

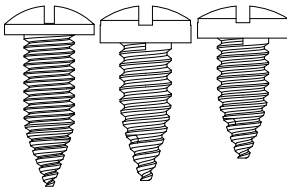

M4.2X14

16x

M3X14

4x

M3X10

16x

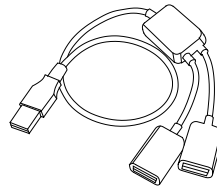

USB

1x

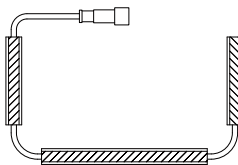

LED lights
Three paragraphs

1x

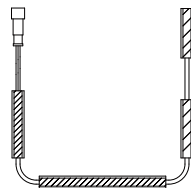

LED lights
Four paragraphs

1x

SMART STEP MANUAL (OPTIONAL)

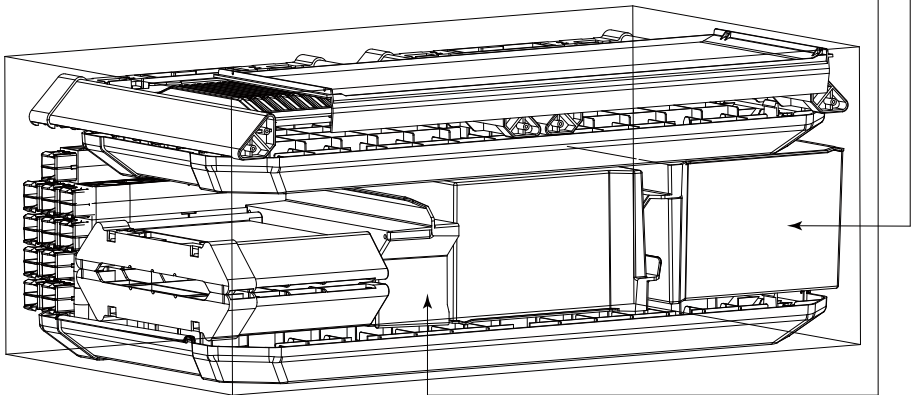
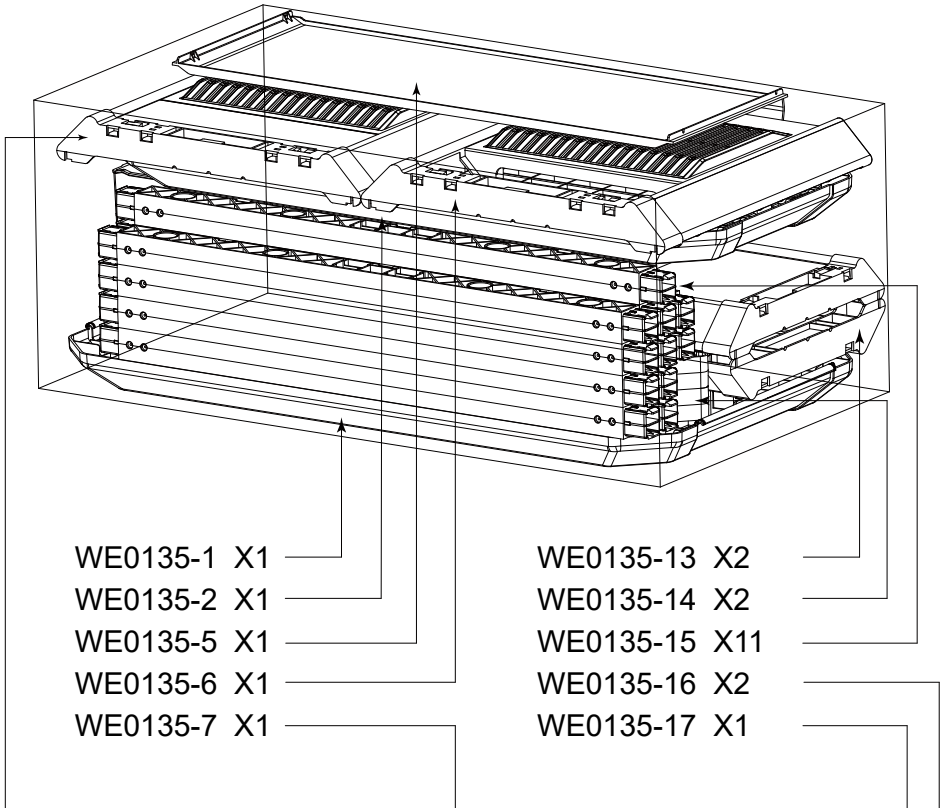

1

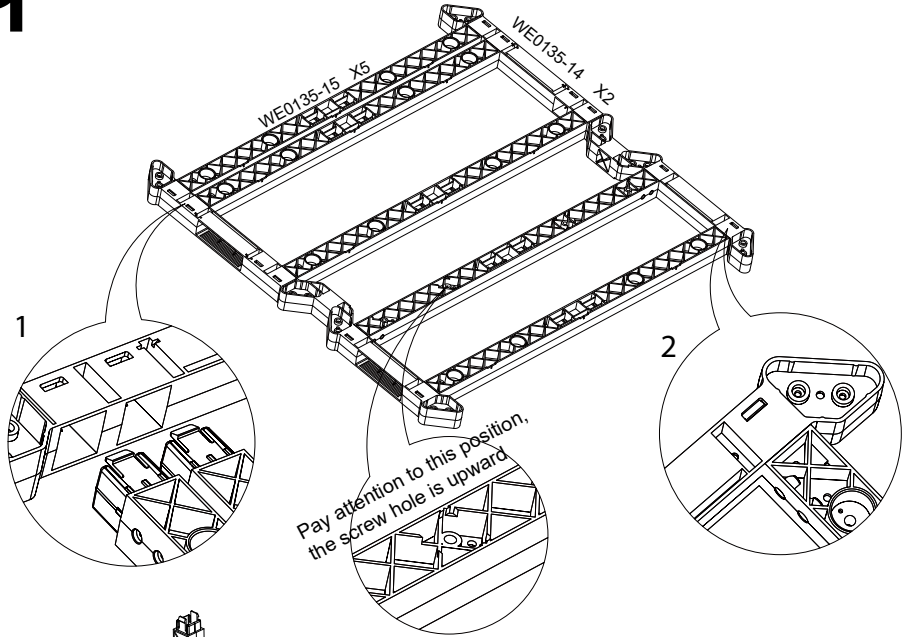

2

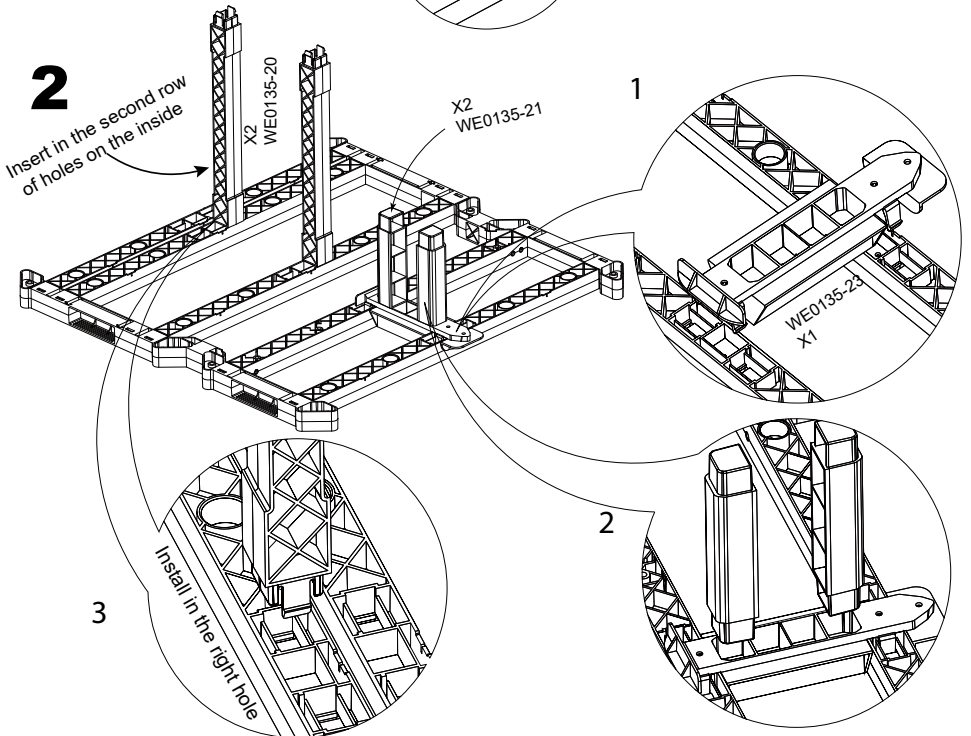

3

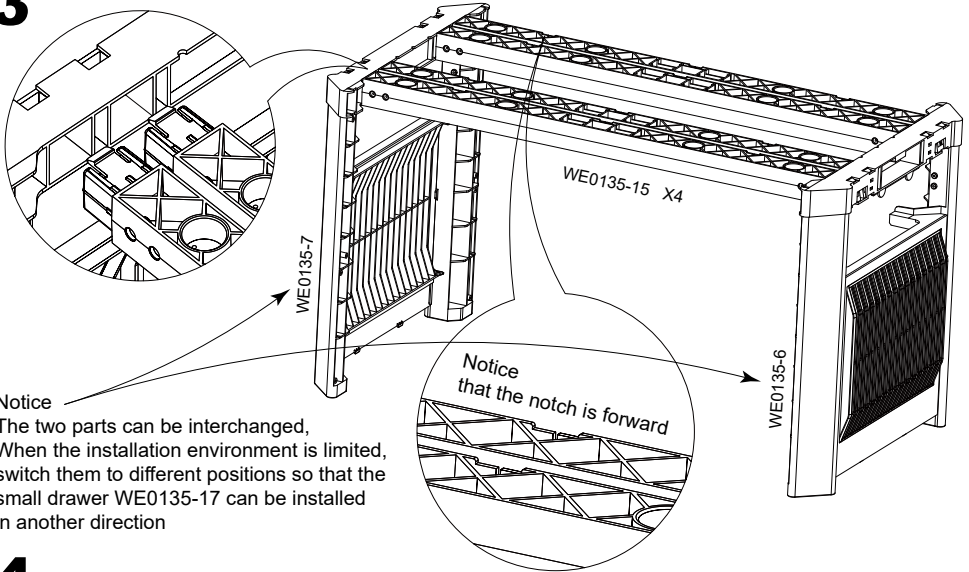

Notice
 The two parts can be interchanged,
 When the installation environment is limited,
 switch them to different positions so that the
 small drawer WE0135-17 can be installed
 in another direction

4

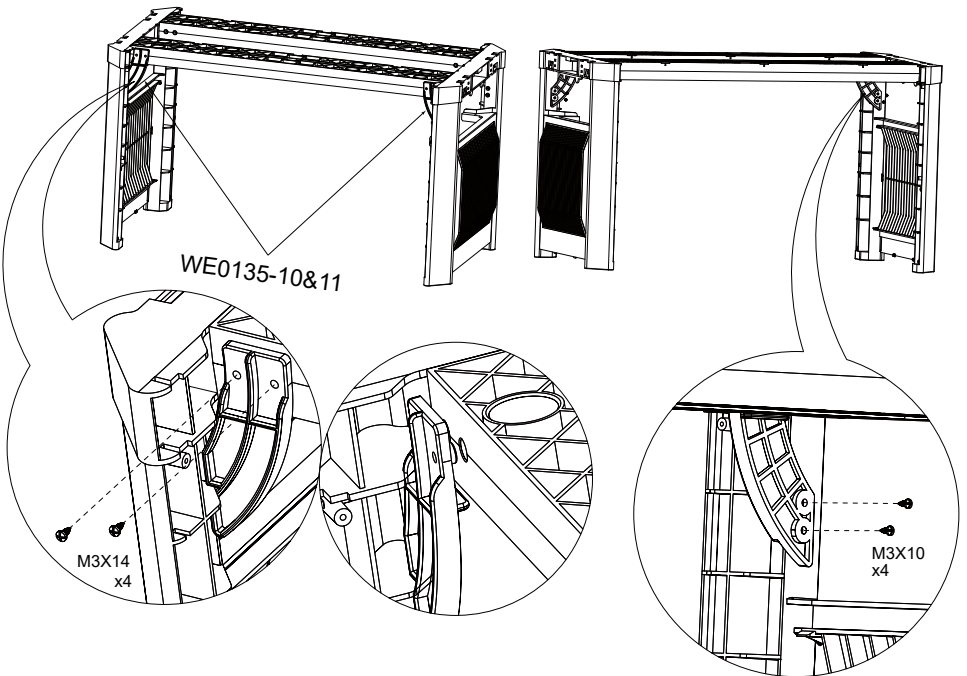

5

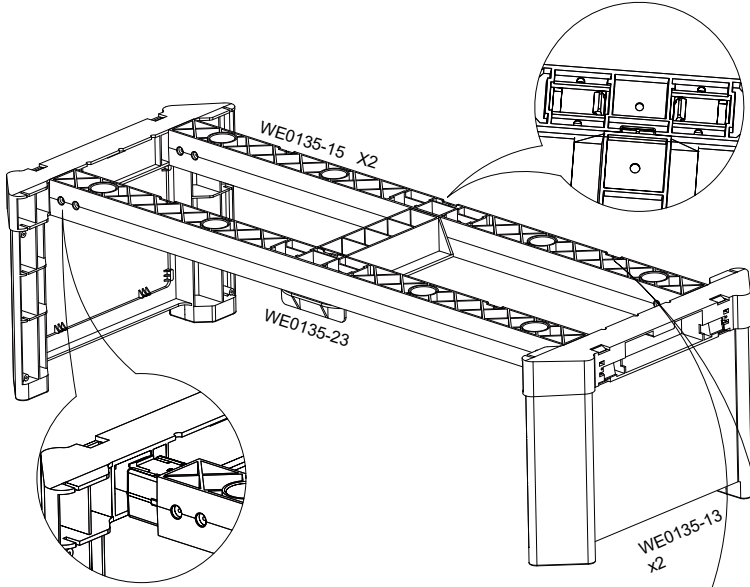

6

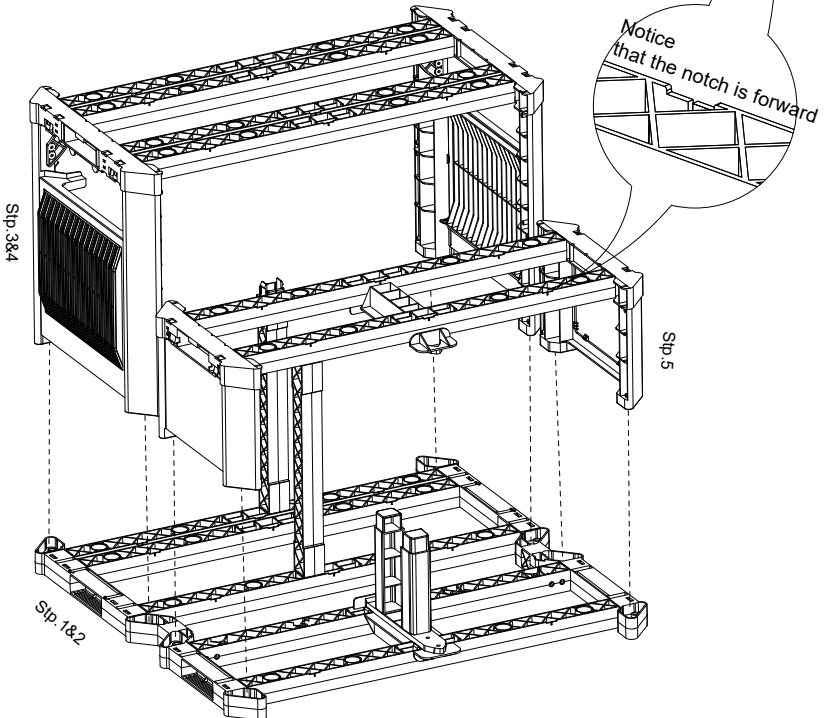

SMART STEP MANUAL (OPTIONAL)

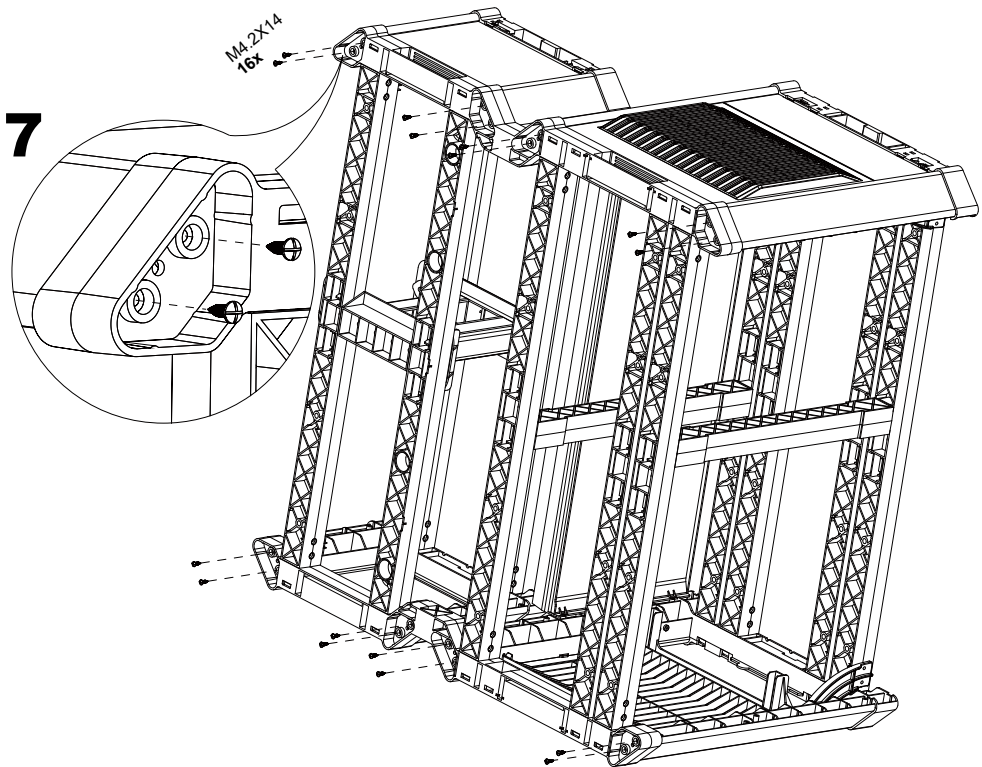
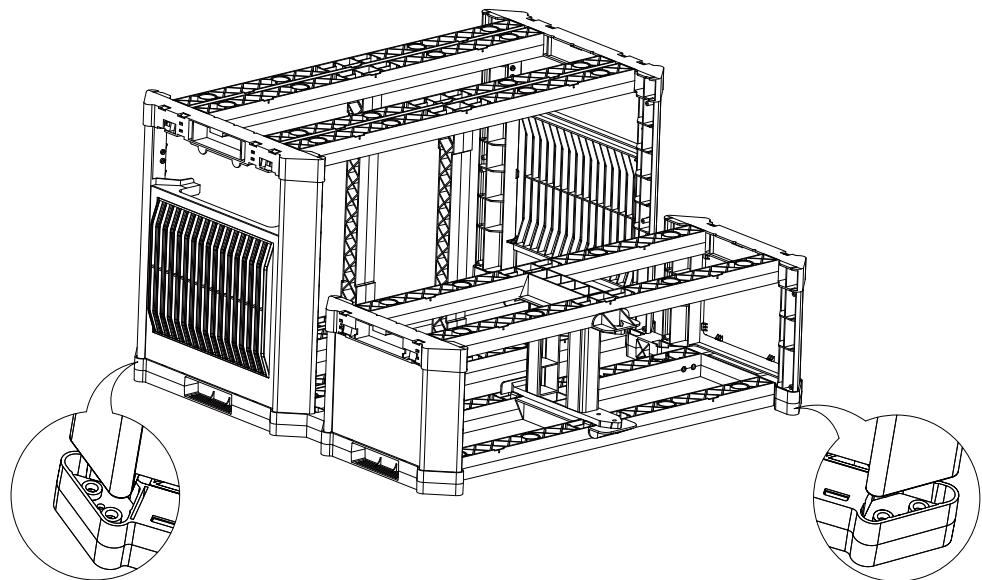

SMART STEP MANUAL (OPTIONAL)

8

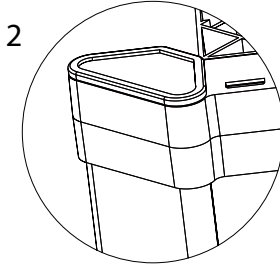
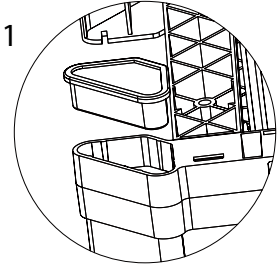
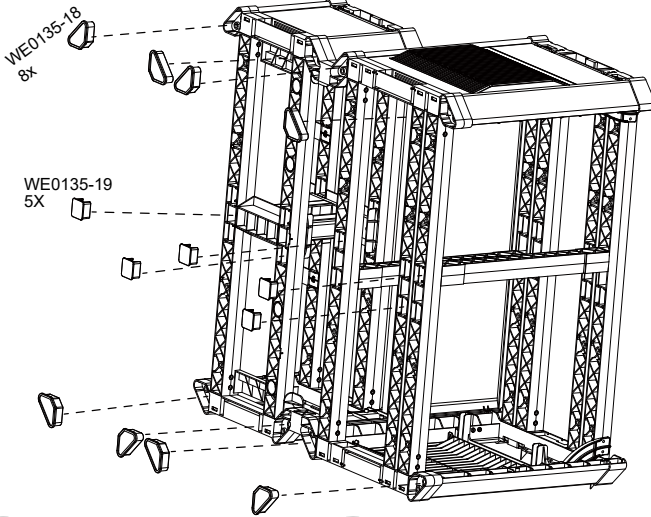

9

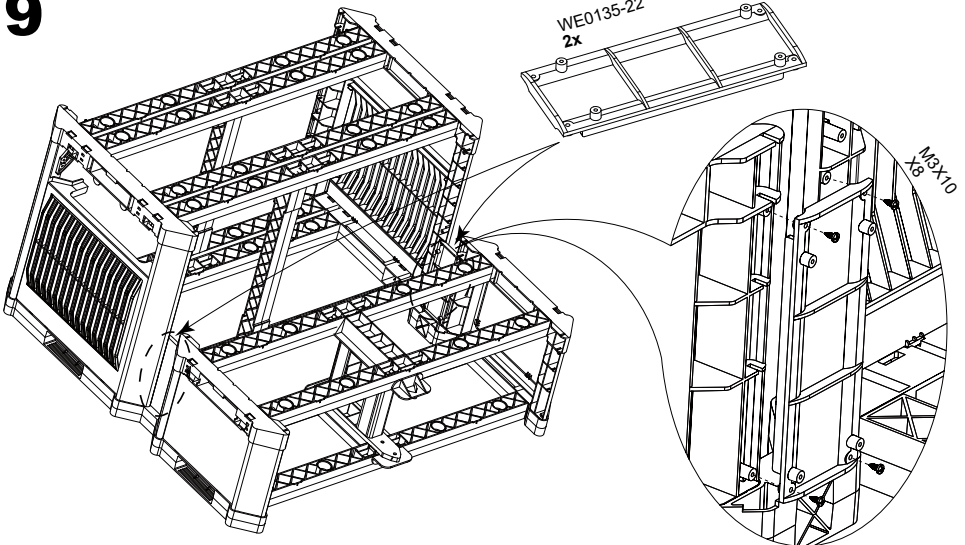

10

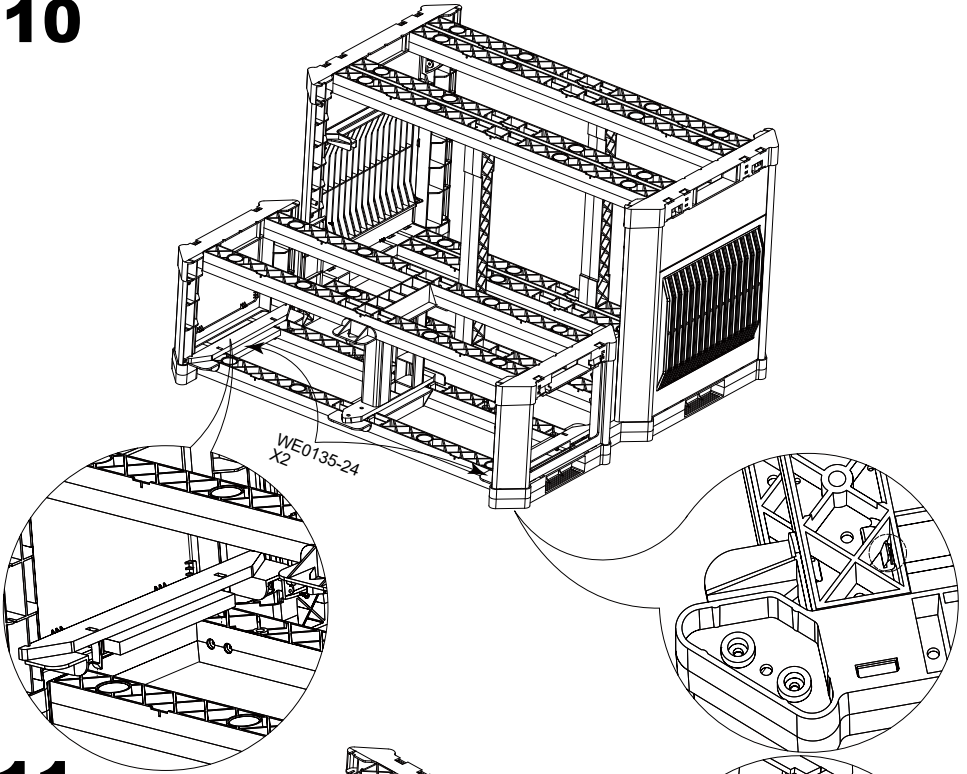

11

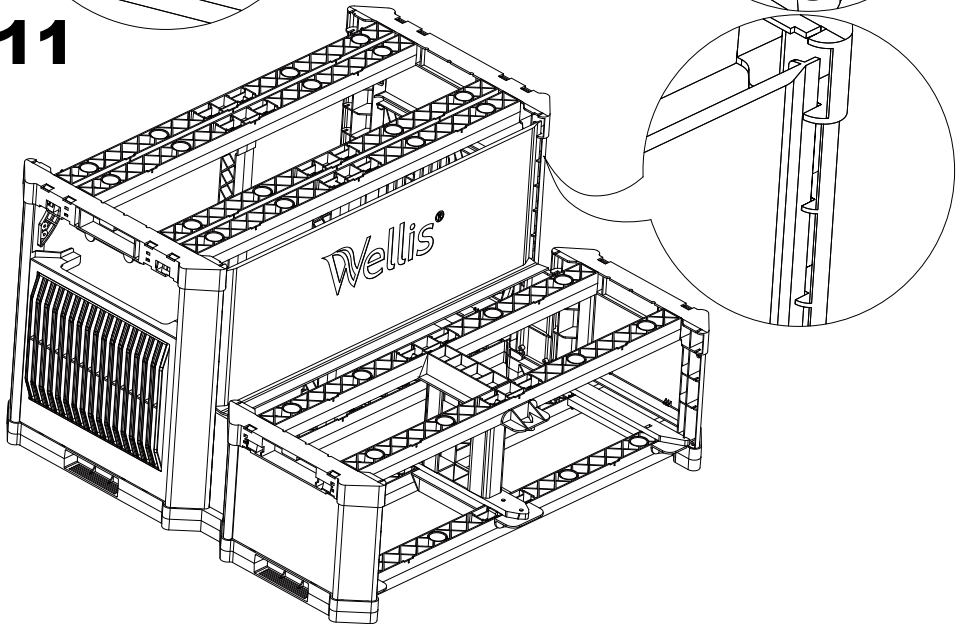

SMART STEP MANUAL (OPTIONAL)

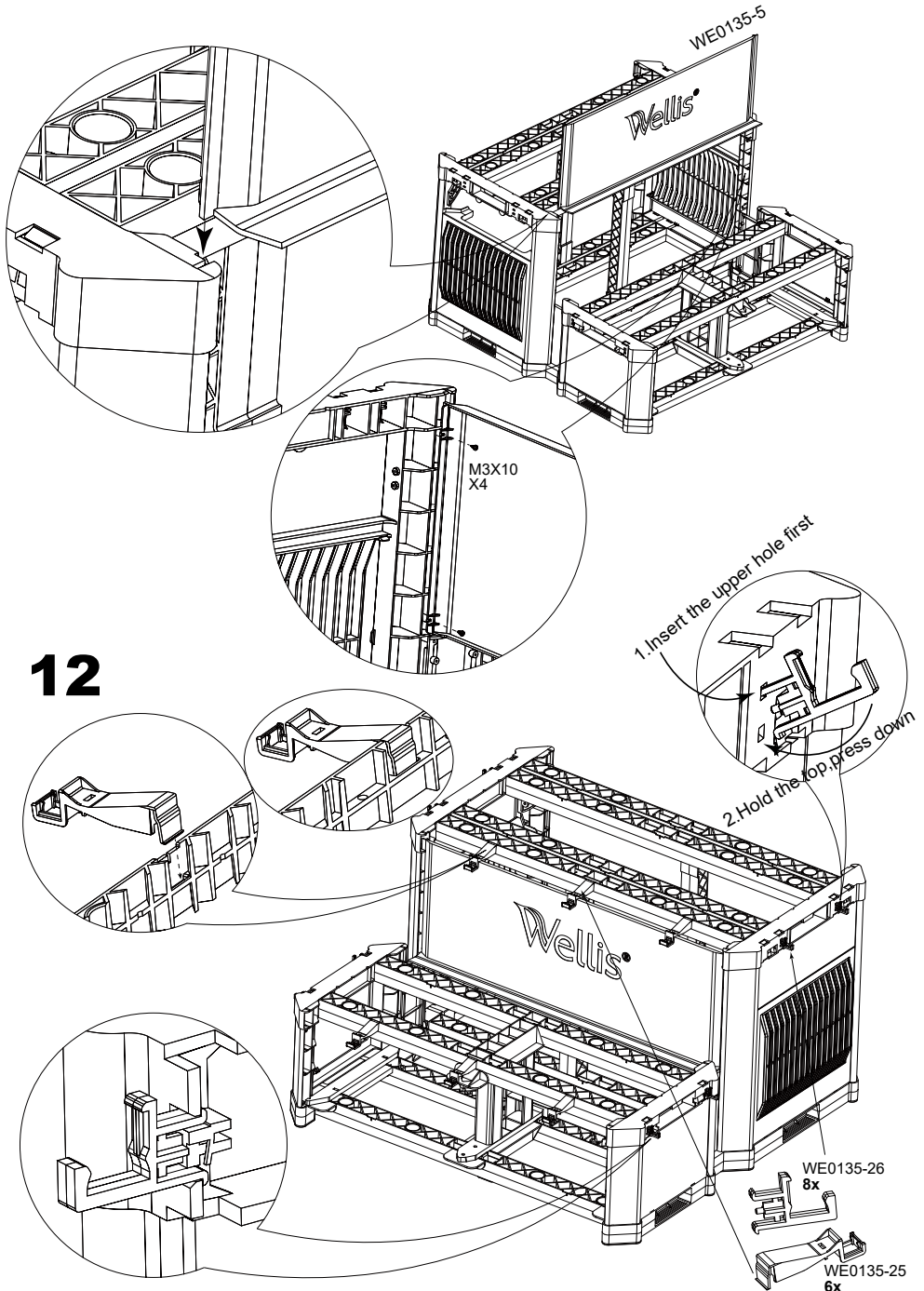

13

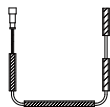

LED lights
Four paragraphs
1x

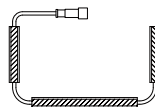

LED lights
Three paragraphs
1x

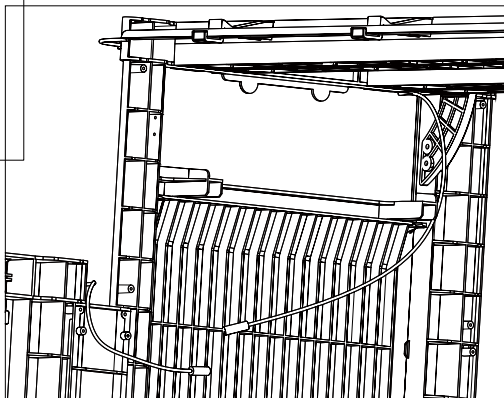
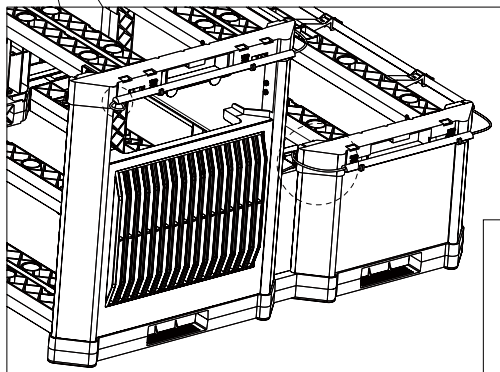
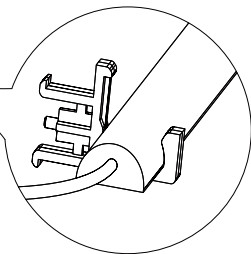
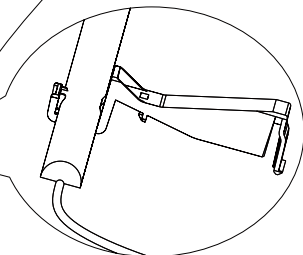
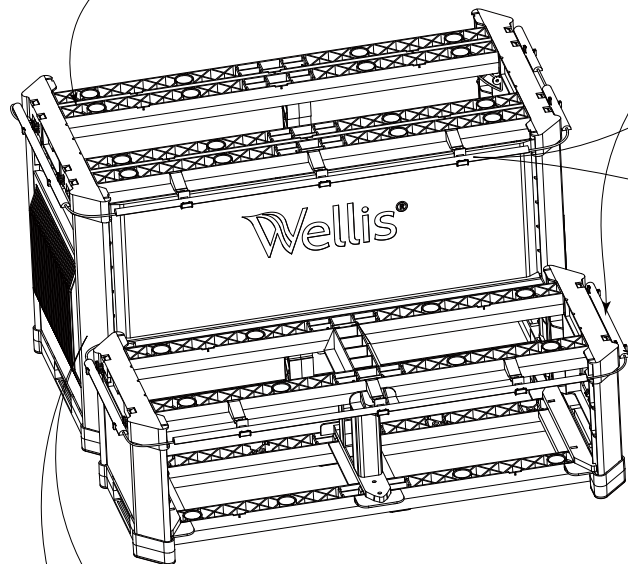

14

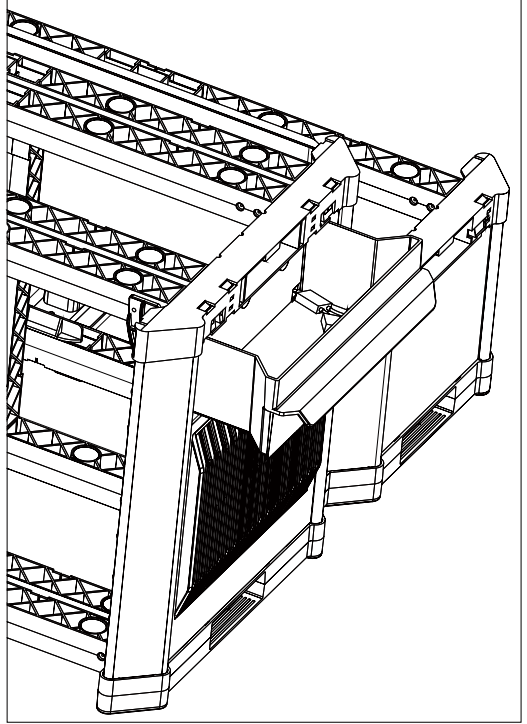
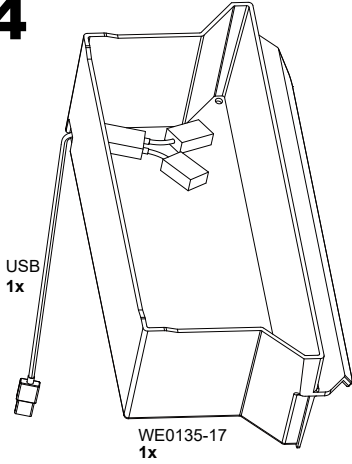

15

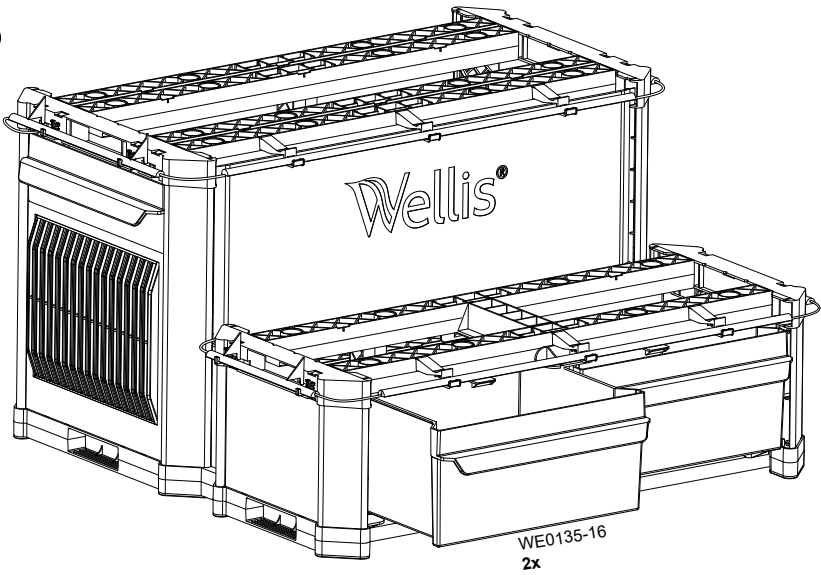

16

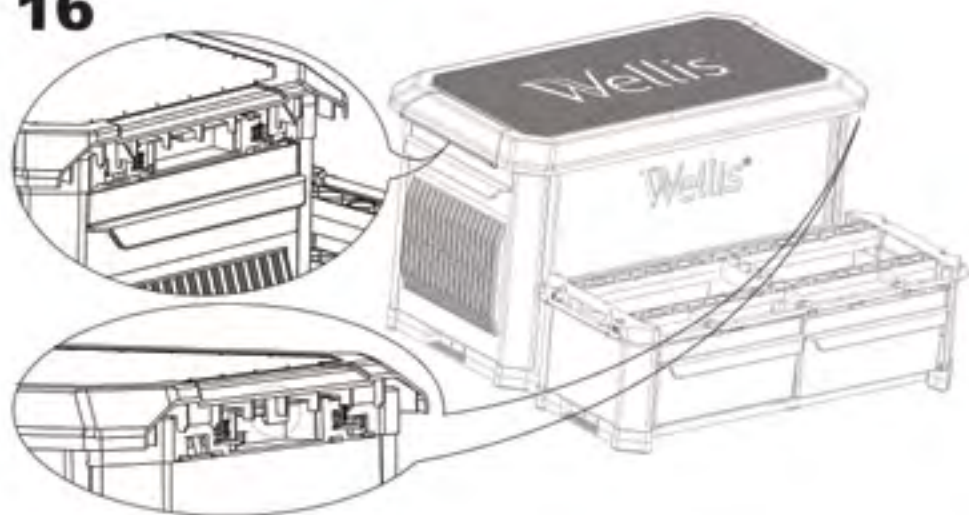

17

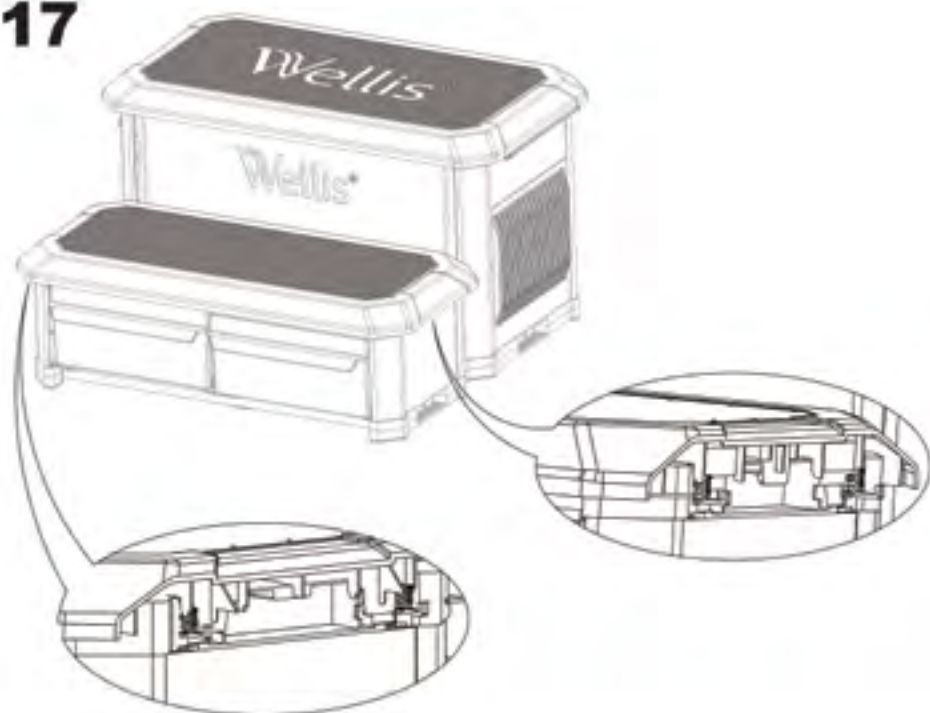

OZMIX SYSTEM - OZONE DISINFECTION

FILTRATION AND OZONE

In a system without circulation pumps the low setting of the massage pump and the ozone generator will switch on during filtration. In a circulation type system ozone starts in a system with circulation pump.

The system is factory programmed for an evening filtration cycle since energy prices might be lower in the evening

(assuming that the time of day is properly set). The filtration time and duration are programmable.

A second filtration cycle can be freely entered.

At the start of every filtration cycle the jets and pumps start to clean the pipes and ensure proper water quality.



Heat Mode Operations

You can choose between four different water regulation modes available. Your in.grid is automatically detected by the spa control system at power up. It will be ready to use with your preferred heat mode one minute following power up.

The relay contacts of the in.grid will be closed if the external heating system is activated. Otherwise, the relay contacts are open.

Your desired heat mode must be set by adding a jumper on one of the five (5) different positions.

***Note:** Your heat mode selection can be changed with the in.touch 2 app on your mobile device. On your app, any new selection will override the jumper setting of the in.grid. The in.touch 2 app will automatically detect the in.grid presence and will adapt its menu configuration as required.

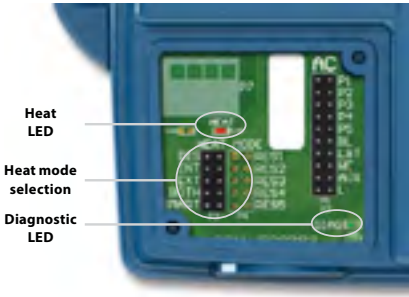

Five available heat modes are offered with in.grid:

1- DIS (DISABLED)

Use this mode if the spa configuration does not have any external heating system and only the single switch functionalities are used. This will avoid in.touch 2 application on a mobile device to display the Heat Mode Selection menu*. The spa controller will regulate the water temperature using the standard resistive heater. The single button switches will control the different spa accessories according to the AC jumper selections.

IMPORTANT: This mode can only be set with the heat mode jumpers.

2- INT (INTERNAL)

This mode provides an easy way to revert back to standard water regulation using the internal heater in case of problem with the external heating system.

3- EXT (EXTERNAL)

Use this mode for a maximum energy saving purpose. The spa control system will only use your external heating system to regulate the water temperature. In normal operation, the internal heater will never be activated.

Freeze Protection

Freeze protection has been added because EXT (EXTERNAL) mode does not allow the activation of the internal heater. In cold weather, if it becomes impossible to keep the water over freezing point, the help of the internal heater will then be needed. This is the only time the freeze protection will come in.

At any time, if the water temperature drops to 40°F (4.5°C), the resistive heater will give a boost to avoid freezing. The freeze protection will stay active until water temperature reaches the minimum allowed set point (usually 59°F / 15°C). Normal EXT mode will resume functioning thereafter.

4- BOTH (BOTH SYSTEMS ALL AT ONCE)

The spa control system will always use the external heating system AND the internal heater simultaneously to regulate the water temperature; they are both activated or deactivated at the same time.

5- SMART (ENERGY SAVINGS)

The spa control system will always use the external heating system to regulate the water temperature. If the temperature falls too far below your set point (-2.5°F), the internal heater will be activated to help your external heating system reach the set point.

Troubleshooting

DIAGNOSTIC LED

The diagnostic LED will help you with the status of the connection between the spa control system and the in.grid.

Blinking light: Spa control system not detected, not compatible or in Disable mode if one of your single switches doesn't operate properly.

Solid light: Spa control system detected

No light: Power Off

HEAT LED

Solid light: Relay contacts close and external heating system on.

No light: Relay contacts open and external heating system off.



in.touch 2

Easily integrate your spa to the Internet of Things!

Simplest of setups

in.touch 2 eliminates all the complexities of connecting your spa to the Internet and transforms your smartphone or tablet into your ultimate Wi-Fi spa remote control. in.touch 2 comes with a state-of-the-art app and 2 prepared radio frequency transmitters, one being part of your spa system and the second one being connected to your Internet router. Both RF transmitters are prelinked to one another, enabling an immediate and perfect communication between you and your spa.

Strong and long range communication signal

Through their proprietary RF technology, in.touch 2 transceivers emit a strong, stable and long range signal between your spa and your router (about 3 times longer than regular Wi-Fi signal). No need for repeaters or boosters: your spa will always remain within reach in typical backyard settings.

State-of-the-art app with push notifications

in.touch 2 streamlined application makes it very easy to control and program all the functions and features of your spa from your smartphone or your tablet. Even when you're away from home, you get full control of your water care settings, filtration cycles, water temperature, economy modes and a lot more. Push notifications will always keep you informed on the status of your spa, even when your app is not open.

in.touch 2 overview

Home Transmitter (EN Module)

Spa Transmitter (CO Module)

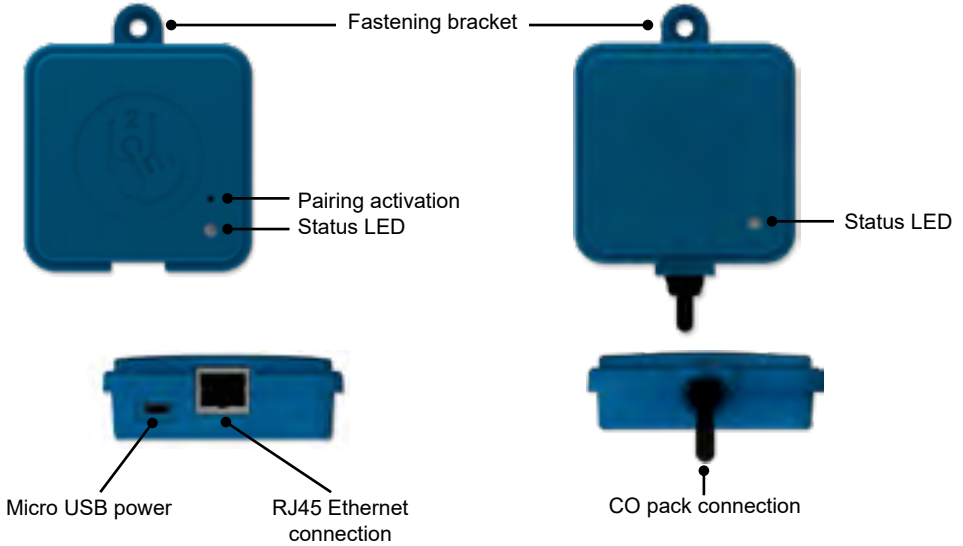

in.touch 2 dimensions

Home Transmitter (EN Module)

Spa Transmitter (CO Module)

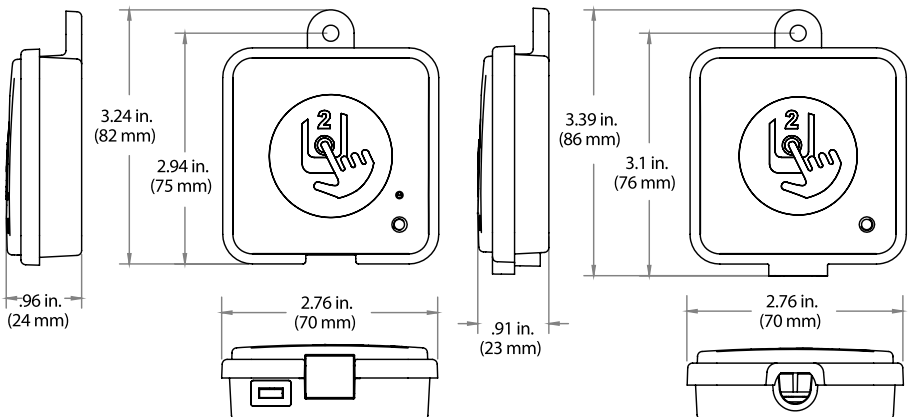

Home Transmitter (EN Module) installation

The Home Transmitter unit must be installed inside the house near the router as it needs to be connected to it. The Home Transmitter is provided with an Ethernet cable and a power supply. If required, a longer cable of good quality can be used by the installer (longer cable not provided) to install the Home Transmitter closer to the spa within the home.

The only requirement for installation location is that household .current be available to power the Home Transmitter using the provided wall transformer.

The Home Transmitter can be fixed in the house to optimize the signal strength. We recommend that you install the unit with a #8 pan head screw.

Here are some suggestions for a successful installation:

- If possible, install device on the first floor of your house.
- If installing in a basement, place at highest level possible and closest to a window.
- Try to install as far as possible from materials that may interfere with signal (ie. metal structures, thick cement walls).
- Install as far as possible from router as the signal emitted by the antenna may interfere with RF signal.



Connection of the Home Transmitter (EN Module)

Simply connect Ethernet cable into the RJ45 port of the Home Transmitter and in one of the available LAN ports on the router.

Finally, to power up the Home Transmitter, connect the provided transformer to a 120V (North American model) or 220V (European model) household supply and connect the USB cable between the transformer and the Home Transmitter.

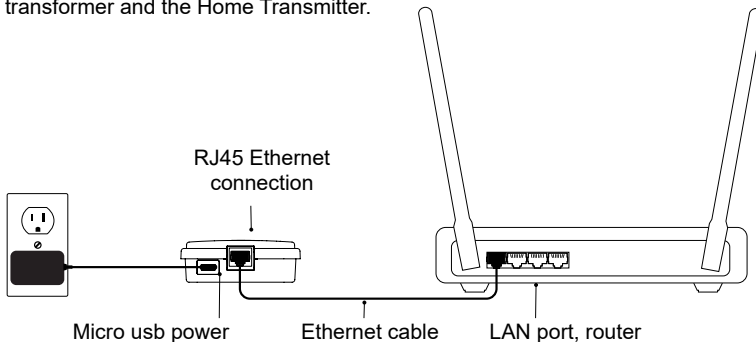

Pairing the Spa Transmitter (CO Module) and the Home Transmitter (EN Module)

The pairing process is used when you need to replace one module of the in.touch 2 kit. Otherwise, the in.touch 2 arrives pre-paired from the factory.

1. Power up the Home Transmitter

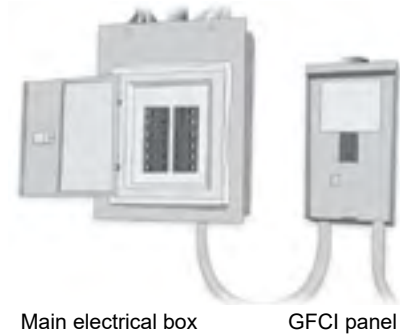
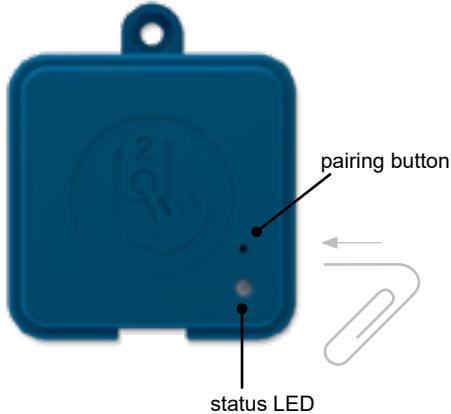

2. Press on the pairing button with a paper clip or some similar tool. When the pairing mode is active the status LED flashes YELLOW in a rapid pattern. The Home Transmitter is then in pairing mode and will remain in this mode until it pairs with an Spa Transmitter, or until it is reset (power cycled).
3. Shut off the spa's breaker (thus turning off the Spa Transmitter), wait a few seconds, and then flip the breaker back on. Within a few seconds, the pairing operation should complete and the Home Transmitter status LED will no longer be YELLOW.

Note: in.touch 2 modules can be paired as often as necessary, but can only be paired with a single counterpart module at a time. Once paired, the modules store this information permanently until the next pairing operation. Pairing information is stored in non-volatile memory, so pairing is not required after a power failure. Only a Home Transmitter can initiate a pairing, so it is important that the pairing begin with putting the Home transmitter module in pairing mode.

If several spas are powered up at the same time with a Home Transmitter in pairing mode (for instance, in a dealer showroom), only the 1st spa to successfully connect to the Home Module will pair. As this can be random, it is recommended that only 1 spa be powered up at a time during the pairing process.

LED

Each in.touch 2 module has a status LED that can be used for troubleshooting purposes. The LED is located on the top of both enclosures.

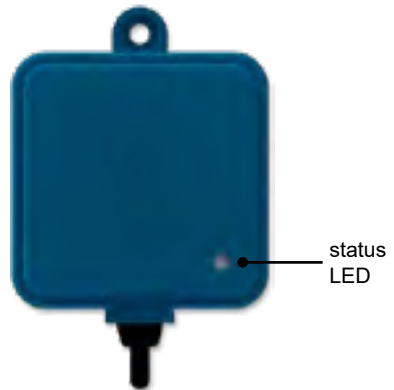
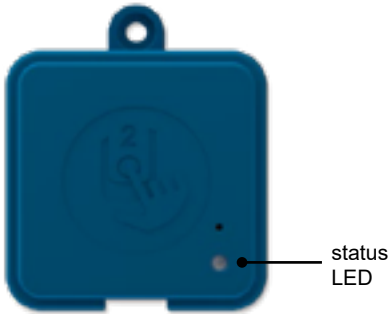

Home Transmitter

Pairing mode Yellow (Blinking)	●
Router not detected	●
Router detected	●
in.touch 2 server detected	●
Module is fully functional	●

Spa Transmitter

Pairing mode Yellow (Blinking)	●
Spa controller not detected	●
in.touch 2 server detected	●
Module is fully functional	●

** When the LED status is blinking (blue, green or red) this indicates that the communication between the EN module and the CO module it not established.*

Download application

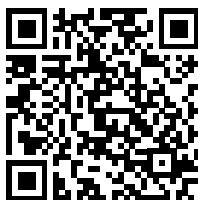

The in.touch app allows you to control your spa using your home network or an Internet connection anywhere in the world. The Wellis Spa Control (in.touch 2) app is waiting for you in the App Store for iOS devices and on Google Play for Android — search for «Wellis Spa Control» then click on it to install.

Use this application

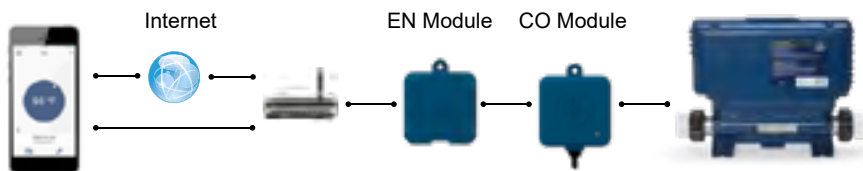

On your home network

It is possible to access your spa with the in.touch 2 app through your home network. To be able to see your in.touch 2 in the application you need to connect your device to the same router (Wi-Fi network) than the one used to connect your Home Transmitter

Go to the Wi-Fi settings section of your mobile device and choose the same network that your spa is connected to (i.e. Home). Once you've selected it, wait until your device confirms the connection.

On the Internet

The in.touch 2 allows you to use the Internet to control your spa from anywhere in the world. In order for them to communicate, both the in.touch 2 module and your device must be connected to a network that allows access to the Internet.

Once your Home Transmitter is connected to the Internet (the LED status is blue), you can use your in.touch 2 app any time your device is also connected to the Internet (wireless or cellular network), even if you are away from home.

To have access to your spa away from home, you will need to have previously linked your mobile device to your spa on your home network.

Setup your Wi-Fi on your device

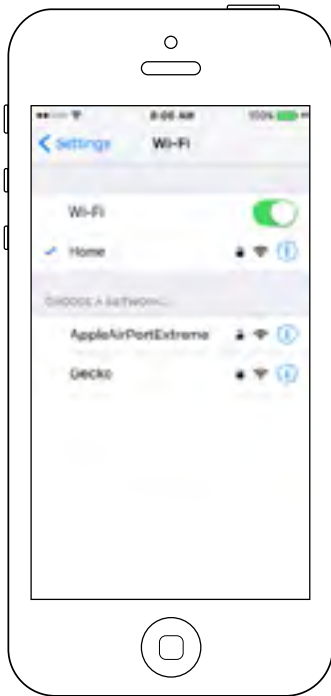

Before using your application, go to the Wi-Fi section of your device's settings. Make sure you are connected to your home network. This needs to be the same Wi-Fi provided by the router to which you connected your Home Transmitter.

Start the Wellis Spa Control application



Find the icon for the in.touch 2 application, then tap on it to open it.

The first time you use the application a message will ask you: "in.touch 2" Would like to send you notifications. If you choose Allow, the application will send you notifications about the status of your spa. If you choose Don't Allow, the application will not send you notifications.

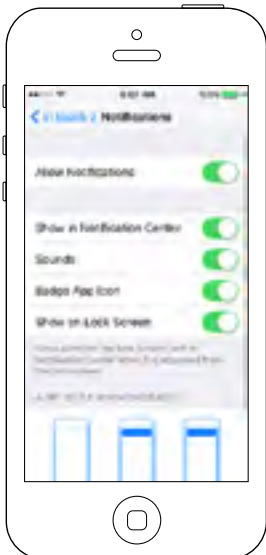

If you change your mind later concerning notifications, you may add or remove notifications for the in.touch 2 application.

On iOS, go in your settings menu and choose in.touch 2. Select the notifications menu, you can turn notifications on or off from this page.

On Android, go to your settings menu and then into the notifications menu. Select the in.touch 2 app, from this page you may turn notifications on or off.

Login page



Before using your application, you must create an account first and then, you'll be able to sign in. Your account will give you the opportunity to have access to your spa from any in.touch 2 application.

New account creation

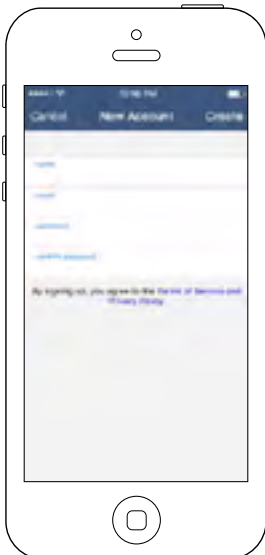

When you choose to create a new account, you agree at the same time our Terms of Service and our Privacy Policy. You can read them at any time through this link: <https://geckointouch.com/legal>

Choose a spa







This page displays all the spas detected by your application.

To detect your spa, you need to connect your mobile device to the same network to which you connected your Home Transmitter.

Once you have done a connection with the spa its name will be saved on this page to allow you to connect to this spa from anywhere.

To add a spa later on, go to p. 26 of this techbook for instructions. The RF signal strength (communication between the two in.touch 2 transmitters) is illustrated on the Select a spa page. There are 5 possible states:

-  • Signal superior to 80%
-  • Signal between 80% and 51%
-  • Signal between 50% and 31%
-  • Signal below 30%
-  • The Spa Transmitter is not available

Home page

The main screen gives you access to your accessories, water temperature, water care and settings.

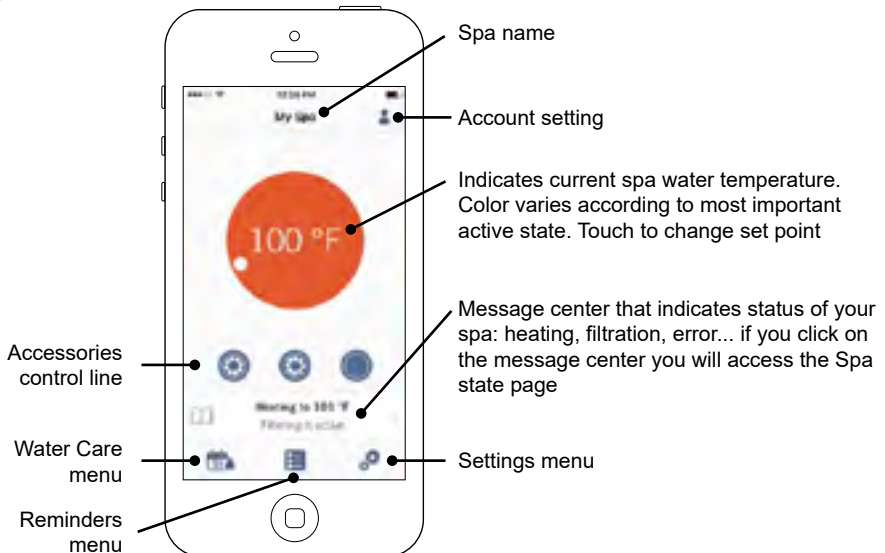

Spa state

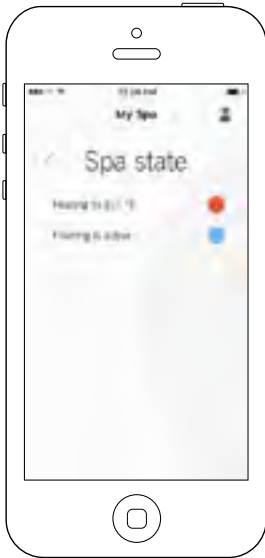

This page displays all the active states of your spa. Below is a quick description of each state you may encounter on your spa. Each state is associated to a priority and color that determines the color of the widget on the home page.

- Indicates that there is an error on your spa.
- Indicates that there is presently an active user demand on your spa (ie. pump, blower or light is on).
- Indicates that your spa is now heating to your set point.
- Indicates that your spa is now in a filtering cycle.
- Indicates that your spa is now in economy mode.
- Indicates that your spa is running normally (there is no user demand, heating, no filtration or economy active).

The widget on the home page displays a single color at a time. The color displayed is decided by priority of state. The established priority is as listed above.

Change temperature

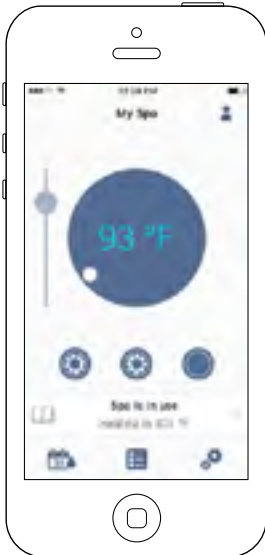

Touch the centered widget to reveal the temperature control bar.

Use the slider on the control bar to change your spa's temperature* set point.

** If you are in economy mode your spa temperature will be 20°F below your set point.*

Turn on/off accessories



According to your spa pack configuration, you can start or stop an accessory by simply touching the associated icon. The icon will become animated when the accessory is on. Simply press on the icon to start or stop the accessory.

If your accessory has more than one speed, press the button until the desired speed is reached.

The icon designs are customized according to your spa pack configuration:



Turn on/off the lights



To control your spa lights, simply press the button to turn it on or off

Control your in.mix 300



This menu is only available if an in.mix 300 is detected in your spa accessories

To turn on or off the in.mix 300, you can use, if you want, the light icon on your home page. To go to your in.mix 300 page, simply swap to the left.

Turn on/off in.mix 300

Swap to in.mix 300

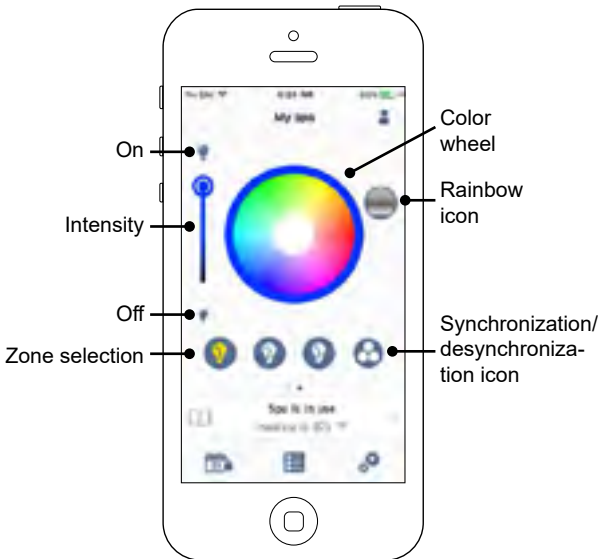

The in.mix 300 page allows you to customize your color zones in or around your spa.

The light bulb icons allow you to turn on and off your in.mix 300.

To select a zone, click on the wanted one in the “zone selection” stripe. To change the color, use the color wheel to choose the one you want. On the left side, the intensity slider allows you to modify the brightness of your lights. Use the rainbow icon to get color gradation.

The synchronization / desynchronization icon gives you the possibility to match the color of the selected zone with the other zones

Water Care

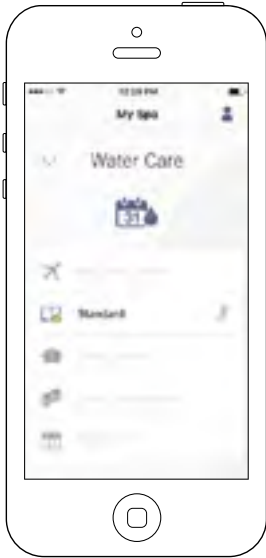

The Water Care page will help you set up your ideal filtration and heating settings. Choose between Away from Home, Beginner, Energy Savings, Super Energy and Weekender, depending on your need. Touch the Water Care name you would like to activate, a green checkmark will appear on the icon, indicating you have selected it.

By default, each Water Care mode has pre-configured schedules of economy and filtration. To modify Water Care options, touch the pencil icon at the right end of the desired Water Care to open its menu.

Below you have a short description of each Water Care at default state:



Away From Home:

In this mode the spa will always be in economy; the set point will be reduced by 20° F.



Beginner / Standard:

The spa will never be in economy mode and will be filtering according to the pack's low level configuration.



Energy Savings:

The spa will be in economy mode during the peak hours of the day and resume normal mode on the weekend.



Super Energy Savings:

The spa will always be in economy mode during peak hours, every day of the week.



Weekender:

The spa will be in economy mode from Monday to Friday, and will run normally on the weekend.

Reminders

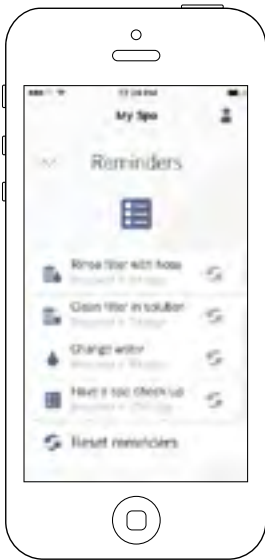

Reminders page will help you to make a follow-up of your maintenance.

The in.touch 2 will remember you to perform required maintenance tasks on your spa, such as rinse filter or clean filter. Each task has its own reminder duration based on normal use. The owner can reset his reminders after the spa maintenance.

Modifying schedules

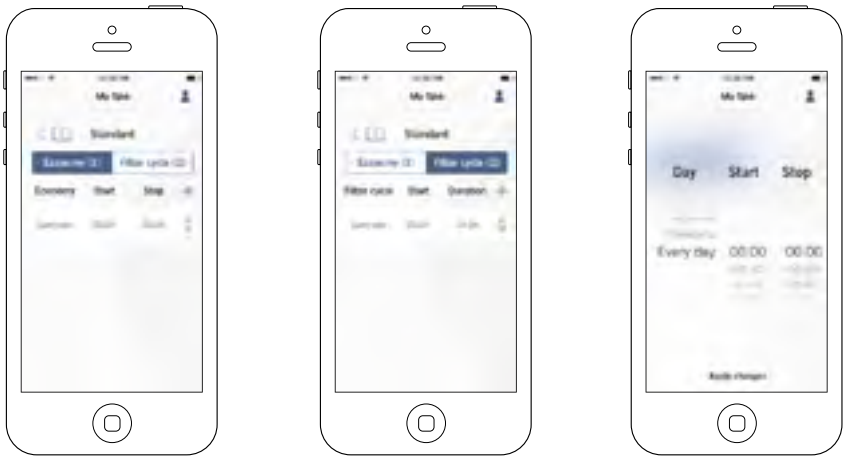

In this menu it is possible to add, remove or edit schedules of economy or filtration.

To have access to this menu, simply touch the tabs:
 Water Care menu - the little pen at the right of the wanted water care

Touch the Economy tab to modify the economy schedules and Filter cycle tab for the filtration schedules. You can add economy or filtration schedules by touching the « + » symbol.

To delete a schedule, touch the garbage can icon at the right end of the desired line.

You can modify the programmed schedules by selecting one and adjusting the schedule.

You have several possibilities for the schedule (Mon-Fri, weekend, every day, or single days). The schedules will be repeated weekly. The time and duration are set in 30 minute increments. Once you have set the schedule, use the arrow at the top of the page to go back. Ensure that you have selected the desired Water Care mode in the main Water Care menu.

When an economy schedule is active, the set point will be reduced by 20°F, which means that the heating system will not be engaged unless the temperature falls to 20°F below the spa's set temperature.

The filtration schedule is applied to the main filtration pump, most likely pump 1. If your spa uses a circulation pump configured to run 24 hours, the screen will show purge schedules instead of filtration. The purges are pre-programmed for a fixed number of minutes, therefore the duration will be set to N/A on the screen and only the start time can be modified.

Spa Settings

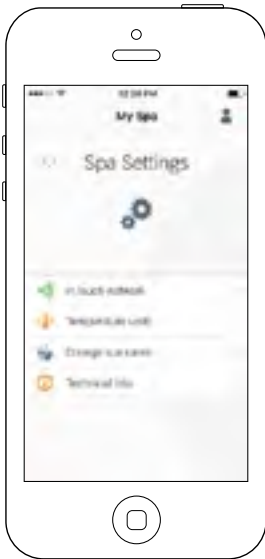

In the Settings page you can access the following:

- *in.touch network*
- *Temperature units*
- *Change spa name*
- *Technical info*

To select an item, tap on the arrow next to it. It will open the selected menu.

in.touch network

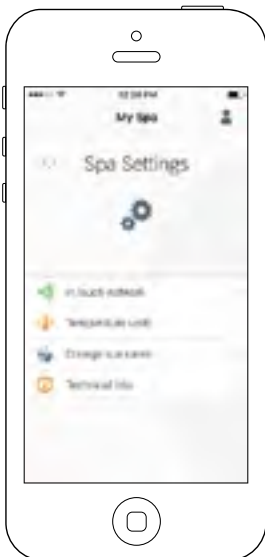

The in.touch network menu allows you to have access to information concerning the RF connection parameters between the Home Transmitter and the Spa Transmitter. This menu gives you access to:

- Channel
- Signal strength
- Reset channel (resets channel to ... default)

To change channels, press on the Channel line.

Change channel



The Change channel page allows you to change the channel used by the two in.touch 2 modules.

In some cases, this can help you to have a stronger signal.

You can have access to this page by touching the following tabs: Spa settings (at the bottom right) - in.touch network - channel

Temperature units



This menu lets you change the units used to display temperature.

You can have access to this page by touching the following tabs: Spa settings (at the bottom right) - temperature units.

Name



This section allows you to edit the name of the spa.

You can have access to this page by touching the following tabs: Spa settings (at the bottom right) - Change spa name

Technical Info



This section shows information about the in.touch 2 software number and the revision numbers of the different components of your system.

You can have access to this page by touching the following tabs: Spa settings (at the bottom right) - Technical info

Settings

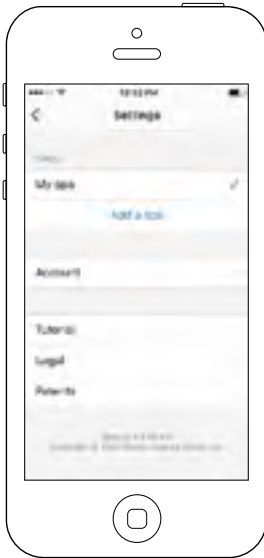

In the Settings page you can access the following:

- *Add a spa from local network*
- *Account*
- *Tutorial*
- **Legal*
- ***Patents*

To select an item, tap on the arrow next to it. It will open the selected menu.

*The button Legal will bring you to this web site :
<https://geckointouch.com/legal>

**The button Patents will bring you to this web site:
<http://geckoportal.com/corpo/#patents>

Add a spa



This page displays all the spas detected by your application.





To detect your spa, you need to connect your mobile device to the same network to which you connected your Home Transmitter.

Once you have done a connection with the spa its name will be saved on this page to allow you to connect to this spa from anywhere.

You can have access to this page by touching the following tabs: Settings (up right corner) - Add a spa

The RF signal strength (communication between the two in.touch 2 transmitters) is illustrated on the Select a spa page.

There are 5 possible states:

-  Signal superior to 80%
-  Signal between 80% and 51%
-  Signal between 50% and 31%
-  Signal below 30%
-  The Spa Transmitter is not available

Account



This section gives you access to your account information.

You can have access to this page by touching the following tabs:
Settings (up right corner) - account

Tutorial



This section gives you a quick overview of your in.touch 2 application's functions.

Technical Support invitation



When you receive an invitation for Technical Support, a red circle will be displayed next to the "setting" logo (top right corner).

Authorizing an invitation

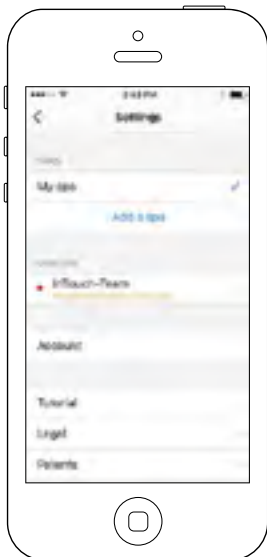

All the invitations you may receive are under the dealers tab in the "settings" menu.

To choose an invitation, simply click on it. You will then see a window authorization to confirm with the dealer's information.

You can also decline the invitation at any time if you want to.

Dealer page



Once you've had a dealer on your in.touch 2 app, you can, at all times, have access to his information.

If you don't want your dealer to have access to your spa anymore, simply swap to the left the "Allow access to your spa" button at bottom of the page.

Both in.touch 2 modules have a status LED to help diagnose problems, if any occur.

Troubleshooting

There are 2 different modules in the in.touch 2 kit: The Home Transmitter (EN Module) and the Spa Transmitter (CO Module). They communicate together via an RF link. The Home Transmitter is responsible for the Ethernet communications and the Spa Transmitter is responsible for the spa communications.

OTHER ACCESSORIES - WELLIS SPA CONTROL (OPTIONAL)

in.grid Heating Management

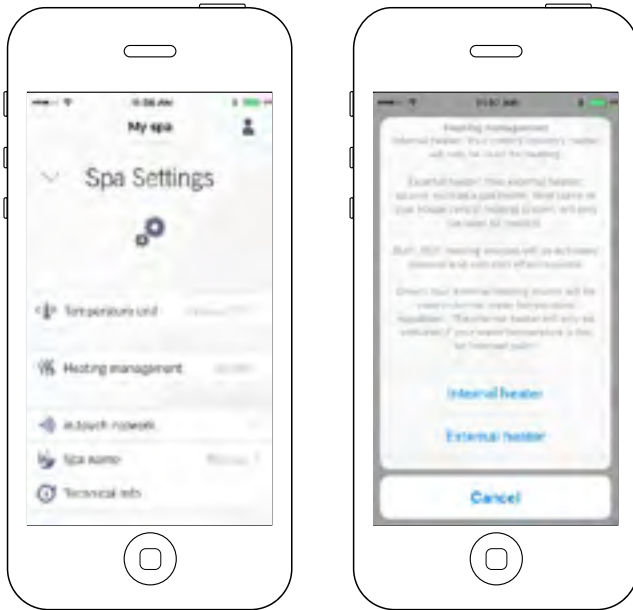

Heating management will appear when an in.grid is detected.

You can change your in.grid heating management without the need to open the spa skirt to change the jumper.

To do so, go to your Spa Settings - Heating management.

You can choose between 4 modes:

- Internal Heater
- External Heater
- Both
- Smart

Both in.touch 2 modules have a status LED to help diagnose problems, if any occur.

Troubleshooting

There are 2 different modules in the in.touch 2 kit: The Home Transmitter (EN Module) and the Spa Transmitter (CO Module). They communicate together via an RF link. The Home Transmitter is responsible for the Ethernet communications and the Spa Transmitter is responsible for the spa communications.

2- INT (INTERNAL)

This mode provides an easy way to revert back to standard water regulation using the internal heater in case of problem with the external heating system.

3-EXT (EXTERNAL)

Use this mode for a maximum energy saving purpose. The spa control system will only use your external heating system to regulate the water temperature. In normal operation, the internal heater will never be activated.

Freeze Protection

Freeze protection has been added because EXT (EXTERNAL) mode does not allow the activation of the internal heater. In cold weather, if it becomes impossible to keep the water over freezing point, the help of the internal heater will then be needed. This is the only time the freeze protection will come in.

At any time, if the water temperature drops to 40°F (4.5°C), the resistive heater will give a boost to avoid freezing. The freeze protection will stay active until water temperature reaches the minimum allowed set point (usually 59°F / 15°C). Normal EXT mode will resume functioning thereafter.

4- BOTH (BOTH SYSTEMS ALL AT ONCE)

The spa control system will always use the external heating system AND the internal heater simultaneously to regulate the water temperature; they are both activated or deactivated at the same time.

5- SMART (ENERGY SAVINGS)

The spa control system will always use the external heating system to regulate the water temperature. If the temperature falls too far below your set point (-2.5°F), the internal heater will be activated to help your external heating system reach the set point.

WIRING DIAGRAM - W2000, W2001

W2000, W2001



ELECTRICAL WIRING

ELECTRICAL WIRING: NORTH AMERICAN MODEL

Refer to wiring diagram in the enclosure box lid for more information.



120 V (3 WIRES)

DO NOT REMOVE THE BROWN WIRE. Insert each wire into the appropriate socket of the main entry terminal block according to the color code indicated on the sticker. Use a flat screwdriver to tighten the screws on the terminal.

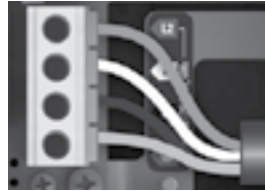

240 V (4 WIRES)

Remove the brown wire and insert each wire into the appropriate socket of the main entry terminal block according to the color code indicated on the sticker. Use a flat screwdriver to tighten the screws on the terminal.

After making sure wires are securely connected, push them back into the box and replace the cover. Do not over tighten cover screws (torque to 8 in.lb max {0.9 N.m.}). Connect the bonding conductor to the bonding lug on the side of the spa pack (a grounded electrode conductor should be used to connect the equipment grounding conductors).

WIRING DIAGRAM - W2000, W2001

CONNECTIONS

CONNECTING THE HEAT.WAV (NOT APPLICABLE ON IN.YJ-RE MODELS)

The in.yj should be paired with a high performance heat.wav heater.

Part numbers:

1,3 kW heat.wav - 0613-421004

2 kW heat.wav - 0613-421002

3 kW heat.wav - 0613-421003

4 kW heat.wav - 0613-421001

heat.wav specification summary:

- in.flo integrated dry-fire protection
- Supports 120 V or 240 V
- Protected by external breaker (not fused)*
- Incoloy® heater element

*Note: CE/AUS/NZS models are 230-240 V only, and are fuse protected.

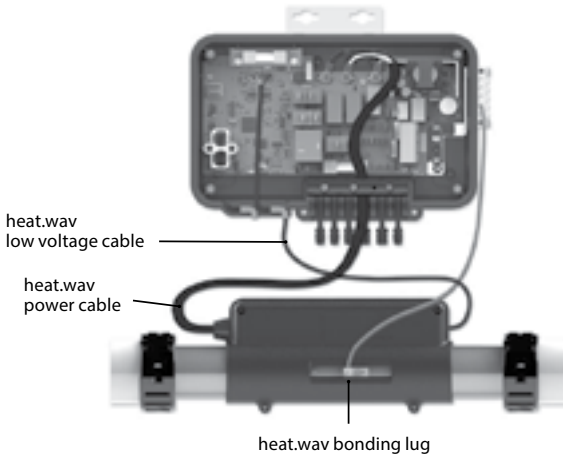

Note: always shut power down before connecting an accessory to the pack.

Connect a solid copper conductor (not smaller than 8 AWG) between the bonding lugs on the side of the spa pack and the bonding lug at the front of the heat.wav. The bonding conductor should be routed close to the contour of the equipment to reduce the risk of damage during servicing.

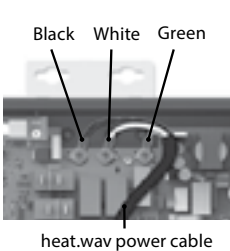

Connect the colored wires
black = P3
white = P4
green = P5

Note: Do not over tighten screws (torque to 18 in. lb max (2.0N.m.) and use of a tool up to 500 rpm max)

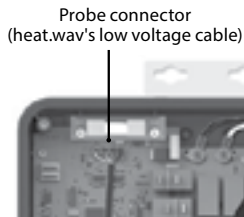

To connect the heat.wav low voltage cable, insert the JST into the probe connector (P1).

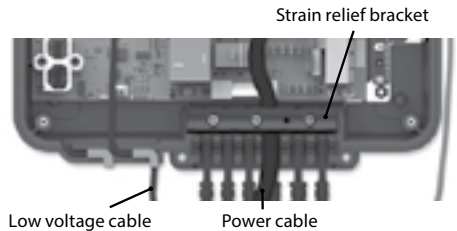

Route the low voltage cable through one of the molded strain relief channels on the bottom of the spa pack.

Remove the small rubber stopper. Route the power cable through one of the openings for 12-3 cable size (as illustrated on page 100).

WIRING DIAGRAM - W2000, W2001

W2000, W2001

OVERVIEW

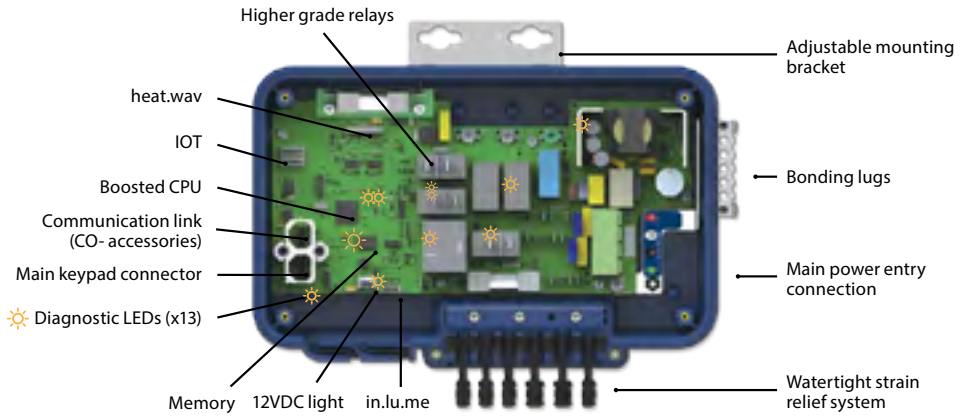

IN.YJ DIMENSIONS

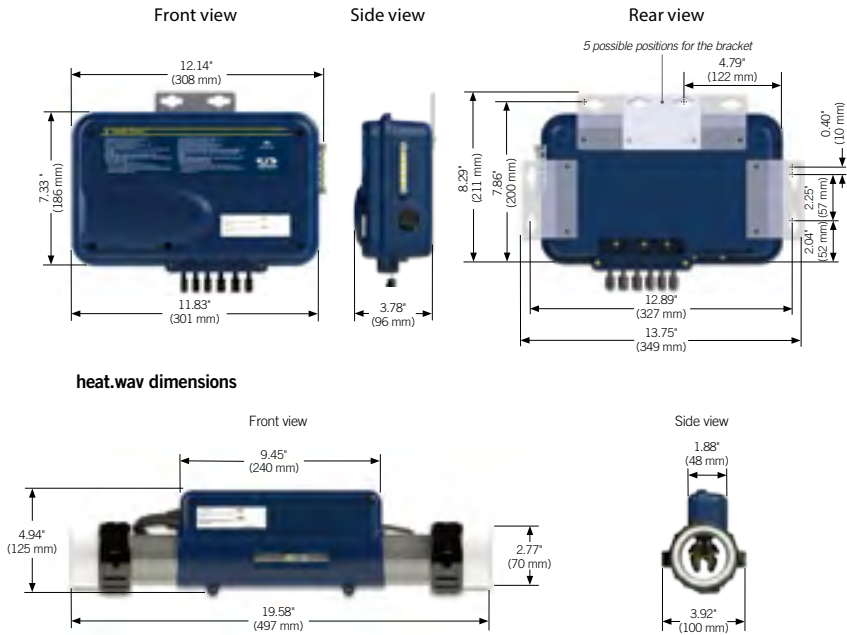

Note: Shown with optional wall mounting brackets (see Installation).

WIRING DIAGRAM - W2000, W2001

CONNECTIONS

CONNECTING HIGH VOLTAGE ACCESSORIES: NORTH AMERICAN MODEL IN.YJ

Wires to connect high voltage accessories must have 0.25" quick-connect terminals.

These tabs require high-voltage accessories to have straight, non-insulated, female quick-connect terminals for all connections, including ground. Depending on where the connections are made on the in.yj pack PCB, 120 V and 240 V accessories are supported. Refer to the following tables for correct connections. Note that all female terminals must be correctly and completely seated on the PCB tab for proper current ratings.

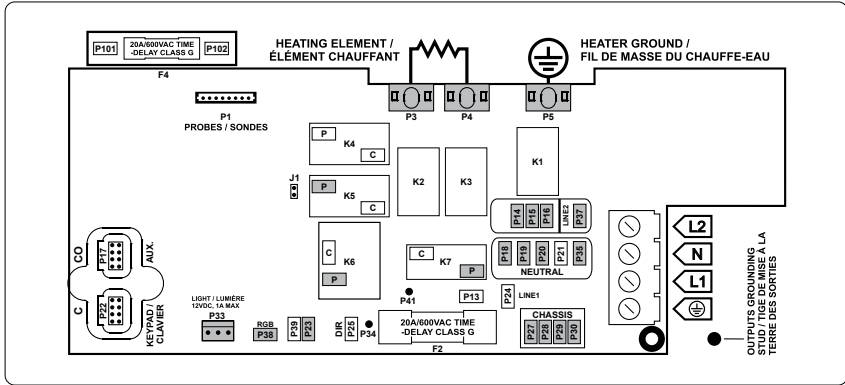

Make sure all accessories are linked to the bonding lug connector located on the side of the spa pack.

DIRECT OUTPUT

Voltage	120 V	240 V
Green / ground	P27	P27
Black / line	P25	P25
White / common	P18	P14

PUMP 1

Voltage	120 V	240 V
Green / ground	P28	P28
Black / low speed	K6-P	K6-P
Red / high-speed	K7-P	K7-P
White / common	P19	P15

PUMP 2

(IN.YJ-3 ONLY)

Voltage	120 V	240 V
Green / ground	P29	P29
Black / low speed	K5-P	K5-P
White / common	P20	P16

OZONE

(WORKING WITH PUMP 1 LOW SPEED)

Voltage	120 V	240 V
Green / ground	P30	P30
Black / line	P23	P23
White / common	P35	P37

LIGHT (12 V DC, 1A)*

Switch	P33
--------	-----

HEAT.WAV-YJ

Green / ground	P5
Black / line	P3
White / common	P4

RGB LEDs IN.LUME (1A)*

Switch	P38
--------	-----

* Combination of both outputs is limited to 1A.

This table shows typical connections. OEMs may have a different connection scheme.

WIRING DIAGRAM - W2000, W2001

CONNECTIONS

COMPLETING THE INSTALLATION

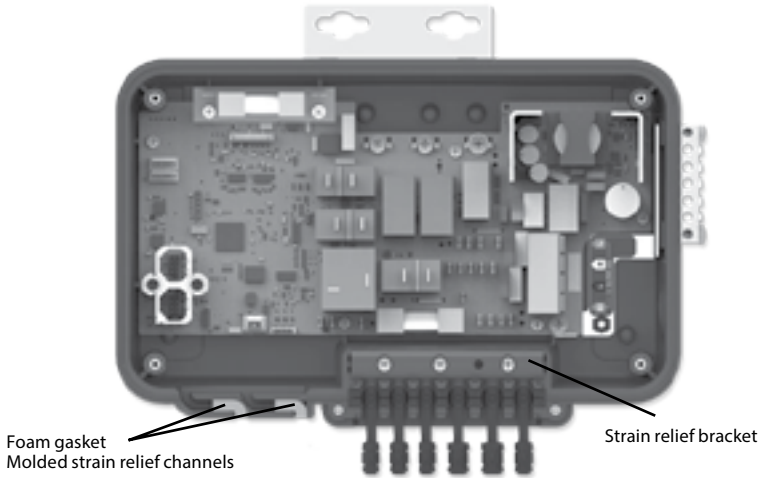

Once all low voltage cables are routed through the molded strain relief on the bottom of the spa pack, fill the remaining space with the foam gasket supplied.

Once all high voltage accessories cables are routed through one of the openings provided for this purpose at the bottom of the spa pack, you can reinstall the strain relief bracket.

Replace the cover. Do not over tighten cover screws (torque to 8 in. lb max (0.9N.m.)

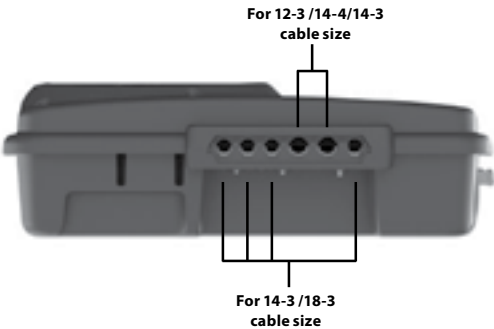

Output cable opening size

WIRING DIAGRAM - W2000, W2001

ELECTRICAL WIRING

ELECTRICAL WIRING: ALL MODELS

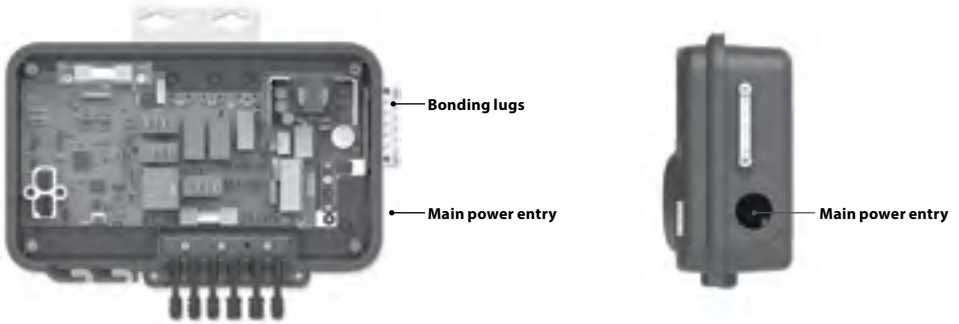

WARNING!

Disconnect power before starting electrical work. Wiring must be completed by a qualified electrician and must be done in accordance with the local electrical code.

Do not use a wire gauge bigger than 8 AWG.

To complete the electrical connections of the in.jy control system you will need a Phillips screwdriver and a flat-head screwdriver.

Remove the screws from the system control lid and remove it.

Remove 5 1/2" (142 mm) of cable insulation.

Strip away 1/2" (15 mm) of insulation from each wire.

Pull the cable through the cutout of the box and secure it with a 3/4" NPT strain relief* (hole diameter 1.09" [27.6 mm]). Ensure that the NPT strain relief clamps around the outer sheath of the cable.

**For CE/AUS/NZ use an IEC certified plastic bushing that will maintain the IPXS rating.*

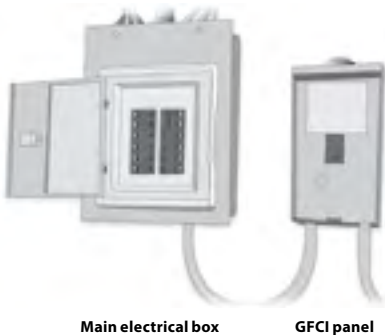

WARNING!

For units for use in other than single-family dwellings, a clearly labeled emergency switch shall be provided as part of the installation. The switch shall be readily accessible to the occupants and shall be installed at least 5' (1.52 m) away, adjacent to, and within sight of the unit.

This product must always be connected to a circuit protected by a ground fault interrupter.

Proper wiring of the electrical service box, GFCI and in.jy terminal block is essential!

Check your electrical code for local regulations. Only copper wire should be used, never aluminum.

Disposal of the product



The appliance (or the product) must be disposed of separately in accordance with the local waste disposal legislation in force.

WIRING DIAGRAM - W3000

W3000



ELECTRICAL WIRING

ELECTRICAL WIRING: NORTH AMERICAN MODEL IN.YE

Refer to wiring diagram in the enclosure box lid for more information.

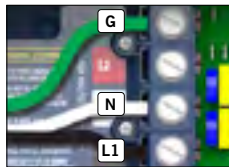
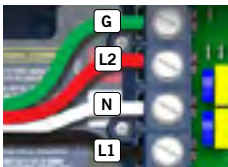

240 V (4 wires)

120 V (*3 wires)

* If connected to a 3 wires system, the heat.wave and accessories will not operate at 240 V.

Refer to the section « Connections for 120 V heaters ».

Note: To convert model to a 120 V system, white cables from the AMP connectors and from all accessories must be shunted. See wiring diagram for details.

Insert each wire into the appropriate socket of the main entry terminal block according to the color code indicated on the sticker. Use a flat-head screwdriver to tighten the screws on the terminal (please refer to the sticker inside the casing to see the torque to apply).

After making sure wires are securely connected, push them back into the box and replace the cover. Do not over tighten cover screws (torque to 8 in. lb max {0.9 N.m}).

Connect the bonding conductor to the bonding lug on the front of the spa pack (a grounded electrode conductor should be used to connect the equipment grounding conductors).

WIRING DIAGRAM - W3000

CONNECTIONS

CONNECTING HIGH VOLTAGE ACCESSORIES: ALL MODELS

Two options are available with Y Series spa packs for connecting high voltage accessories: 0.250" quick-connect terminals, or AMP connectors conform to industry standards.

CONNECTING HIGH VOLTAGE ACCESSORIES: NORTH AMERICAN MODEL IN.YE

For the connection to the 0.250 inch terminals, the high voltage accessories must be provided with female quick connect terminals, straight and non-insulated for all types of connections, including the ground. Accessories of 120 V or 240 V may be connected to the corresponding terminals of the printed circuit of the in.ye. Refer to the following tables for correct connections. Note that all female terminals must be correctly and completely seated on the printed circuit terminals for proper current ratings.

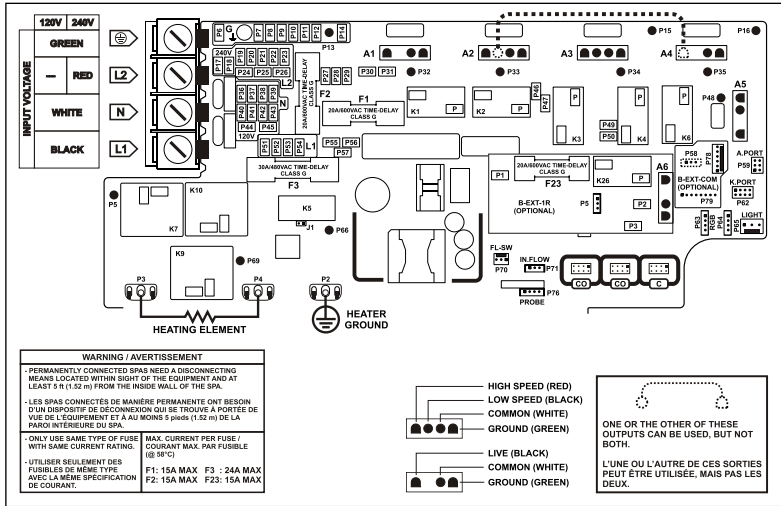

CONNECTION FOR MODEL WITHOUT AMP CONNECTORS:

DIRECT OUTPUT 1 (A5)

Voltage	120 V	240 V
	Green / ground	P11
Black / line	P49	P49
White / common	P44	P24

PUMP 1 (A3)

Voltage	120 V	240 V
	Green / ground	P8
Black / low speed	K2-P	K2-P
Red / high speed	K4-P	K4-P
White / common	P38	P21

PUMP 2 (A2) (in.ye-5 only)

Voltage	120 V	240 V
	Green / ground	P8
Black / low speed	K6-P	K6-P
Red / high speed	K3-P	K3-P
White / common	P37	P20

PUMP 3 (A4) (in.ye-5 only)

Voltage	120 V	240 V
	Green / ground	P10
Black / line	K6-P	K6-P
White / common	P39	P22

Optional output (A26) (in.ye-4 or -6 only)

Voltage	120 V	240 V
	Green / ground	P12
Black / line	K26-P	K26-P
White / common	P45	P26

Circulation pump* (A1)

Voltage	120 V	240 V
	Green / ground	P7
Black / line	K1-P	K1-P
White / common	P36	P19

Pump 2 (A2) (in.ye-3 only)

Voltage	120 V	240 V
	Green / ground	P8
Black / low speed	K2-P	K2-P
White / common	P37	P20

Light (12 V dc, 1.3 A Max.)**

P65

LEDs RGB (in.lu.me only)

P63; P64

* Ozonator and circulation pump can be combined on the same output via the optional splitter PP1.

** Max. available current for Light and LEDs RGB together.

This table shows typical connections. OEMs may have a different connection scheme.

WIRING DIAGRAM - W3000

CONNECTIONS

HEAT.WAV WATER HEATER CONNECTIONS

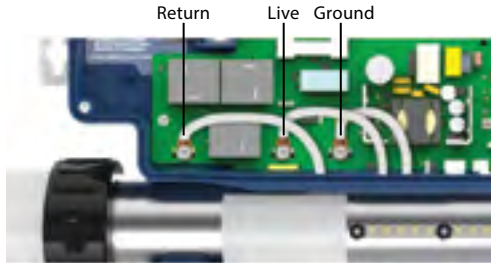
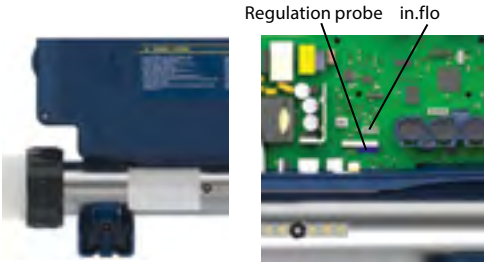

in.ye systems come with a high performance heat.wav heater. With no pressure switch, it features in.flo integrated dry-fire protection.

The heat.wav heater is factory configured for 240 V / 4 kW, but it can be converted to a dedicated 120 V / 1 kW by simply adding a cable connection. (120 V conversion is available on North American in.ye-3 models only).

The heat.wav heater is also offered in 240 V / 5,5 kW or 240 V / 2 kW versions.

heat.wav specification summary:

- Supports 120 V or 240 V
- Incoloy® heater element
- Protected by external breaker (not fused)*

**Note: European models are 230-240 V only and are fuse protected.*

Part numbers:

9917-101959 (cable for conversion)

9920-101449 (5.5 kW heat.wav heater)

All heater connections are accessible when the cover is removed. These previously mentioned connections are installed from manufacturing and must not be removed. Connections include the in.flo dry-fire protection, hi-limit/regulation probe connectors, power and ground cable connections.

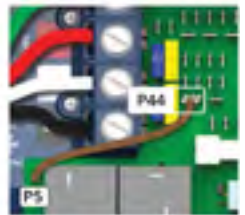
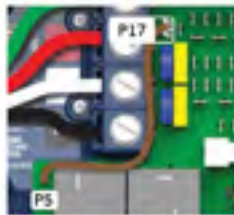

Connections for 240 V heaters (North American installations only)

BROWN wire must be correctly connected between P5 and P17.

Connections for 120 V heaters (1 kW)

BROWN wire must be correctly connected between P5 and P44.

Note: To convert model to a 120 V system, whites cables from the AMP connectors and from all accessories must be shunted. See wiring diagram for details.

WIRING DIAGRAM - W3000

ELECTRICAL WIRING

ELECTRICAL WIRING : ALL MODELS



Warning

Disconnect power before starting electrical work. Wiring must be completed by a qualified electrician and must be done in accordance with the local electrical code.

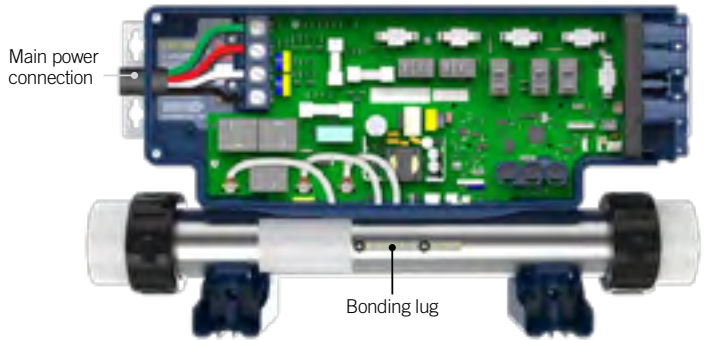

To complete the electrical connections of our in,ye control system you will need a Phillips screwdriver and a flat-head screwdriver (slotted head size between 5/16" and 3/8").

Remove the screws from the system control lid and remove it.

Remove 5 1/2" (142 mm) of cable insulation.

Strip away 1" (25 mm) of insulation from each wire.

Pull the cable through the cutout of the box and secure it with a NPT strain relief* (hole diameter 1,335" [34,42 mm]). Ensure that the NPT strain relief clamps are around the outer sheath of the cable.

* For CE use an IEC certified plastic bushing that will maintain the IPX5 rating.

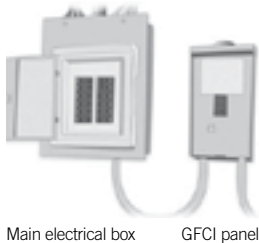

Main electrical box

GFCI panel



Warning

For units to be installed in other than single-family dwellings, a clearly labeled emergency switch shall be provided as part of the installation. The switch shall be readily accessible to the occupants and shall be installed at least 5' (1.52 m) away, adjacent to, and within sight of the unit.

This product must always be connected to a circuit protected by a ground fault interrupter.

Proper wiring of the electrical service box, GFCI and in,ye terminal block is essential!

Check your electrical code for local regulations. Only copper wire should be used, never aluminum.



Disposal of the product

The appliance (or the product) must be disposed of separately in accordance with the local waste disposal legislation in force.

BREAKER SETTING



Config

Please do not make changes in the electrical configuration section unless you are a qualified electrician.

In this section you can change the low-level configuration, number of phases, input current and heat pump current.

Use Up/Down to move between parameters, and the Light key to select a parameter to change. Please refer to the techBook of your specific control system for spa for details about the low level settings.

Once you have changed the Number of Phases in the menu, you will be unable to use the Up/Down keys to return to the Low-level Configuration menu. Please go back and re-enter the Config menu.

Note with version 15.00 and higher:

Depending on the pack configuration, a code may be required to change these settings. This code is "5555".

POWER UP

IMPORTANT Please read the following before starting the device.

Verify that all accessories are linked to the ground lug and connected to the to the control system.

A minimum flow of 68 LPM (18 GPM) is required. Make sure that all valves are open in the hot tub plumbing and that the water flow is sufficient between the main pump and the water heater.

Turn on the breaker.

IN.FLO DRY-FIRE PROTECTION

At start up, the in.flo's detector verifies the water flow according to the following sequence:

The Pump 1 or the circulation pump runs for a period of 2 to 5 minutes.

The display will show "--" during the flow verification. After this time, the system confirms if flow is adequate or not.

If the flow is sufficient, the temperature of the water is displayed on the keypad screen. When the water has reached the consigned temperature plus 0.45°C (0.8°F), the water heater turns off.

DISPLAY SEQUENCE AT START UP (EVERY PARAMETER IS DISPLAYED FOR 2 SECONDS)

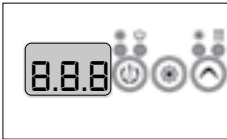

Lamp test

All segments and LEDs light up.

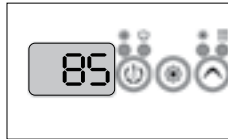

Software number

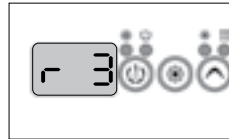

Software revision

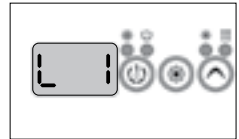

Low-level selected

Low-level selected from the low-level menu.

COMMON HARDWARE ISSUES

Problem	Usual Cause	Solution
System not operating	<ul style="list-style-type: none"> – House circuit breaker tripped or in OFF position 	<ul style="list-style-type: none"> – Reset circuit breaker on house breaker panel
Heater not operating	<ul style="list-style-type: none"> – Water level too low – Heater mode not selected – No power to heater – Heater not operating – Jets are closed 	<ul style="list-style-type: none"> – Add water to reach 6" (15.5 cm) below top lip of spa – Open all jets – Refer to temperature/heater functioning – Check house circuit breaker – Contact dealer
Water not clean	<ul style="list-style-type: none"> – Clogged or blocked floor suction or skimmer – Filter clogged (dirty) – Poor water chemistry – Insufficient filtering time – Improper maintenance – High content of solids in water 	<ul style="list-style-type: none"> – Clean floor suction/skimmer – Remove blockage – Clean or replace – See Maintenance section – Run filtration mode longer – Contact dealer – Use clarifier or drain and refill spa
Abnormal water usage	<ul style="list-style-type: none"> – Excessive evaporation and/or splashing 	<ul style="list-style-type: none"> – Use spa cover and refill as necessary
Overheating	<ul style="list-style-type: none"> – High ambient temperature 	<ul style="list-style-type: none"> – Contact dealer
Low water flow from jets	<ul style="list-style-type: none"> – Operating in FILTER mode-low speed – Clogged or blocked suction or skimmer – Dirty filter – Jets in OFF position – Slice valves closed 	<ul style="list-style-type: none"> – Select hi-speed jets – Clean floor suction/skimmer – Remove blockage – Clean or replace – Open jets – Contact dealer
Noisy pump and motor	<ul style="list-style-type: none"> – Clogged floor suction or skimmer – Low water level – Damaged or worn motor bearings 	<ul style="list-style-type: none"> – Clean floor suction/skimmer – Add water to normal water level (6" or 15.5 cm below lip) – Contact dealer
No water flow from jets	<ul style="list-style-type: none"> – Pump not primed – Adjustable jets turned off – House circuit breaker tripped, no power to system – Faulty pump or motor – Pump surges – Slice valves closed 	<ul style="list-style-type: none"> – See Priming section – Turn on jets – Reset circuit breaker at house panel – Low water. Check level on Weir door – Contact dealer
Water leakage from under spa	<ul style="list-style-type: none"> – Check unions & drain hoses 	<ul style="list-style-type: none"> – Close or tighten as necessary
No air flow from jets	<ul style="list-style-type: none"> – Air control not open – Jet nozzle not seated properly – Jet nozzle missing 	<ul style="list-style-type: none"> – Open control – Check jet nozzles – Inspect jets and replace as needed
Motor will not operate	<ul style="list-style-type: none"> – House circuit breaker tripped or in OFF position – Improper or defective wiring or electrical supply – Thermal Overload Protection switch tripped 	<ul style="list-style-type: none"> – Reset circuit breaker – Contact dealer – Auto reset after motor has cooled. Contact dealer if motor continues to cycle
The spa will not shut off	<ul style="list-style-type: none"> – Spa trying to heat – Spa is in filter cycle 	<ul style="list-style-type: none"> – Check Set Temperature – Check Filter Times

